



Automation for a Changing World

Delta AC Servo Drive & Motor ASDA-A3 Series

Delta High-end Servo System ASDA-A3

More Responsive, Better Accuracy and
Remarkable Robust Control





Cutting-edge Specifications

- 3.1 kHz bandwidth
- 24-bit absolute type encoder
- High speed motor with 6000 r/min and 350 % peak torque
- Motor with high or low inertia rotor
- Low cogging torque motors
- Supports a variety of motors
- Full-closed loop control function



System Tuning and Safety Functions

- System diagnosis function
- Low frequency vibration suppression function
- Auto-tuning function
- Advanced notch filters
- Safe Torque Off (STO) function



Motion Inside

- Advanced motion commands
- Built-in camming functions
- Capture and compare functions



Energy-Saving and Compact Size Design

- DC-bus sharing feature
- Thinner size servo drives
- Smaller size servo motors



Smart and Intuitive Software Interface

- Tree-view index window
- Graphical interface for parameter settings
- Auto-tuning wizard for gains
- Advanced gain tuning interface
- System analysis in Bode Plot
- Oscilloscope function
- Graphical programming interface of PR mode



Ordering Information

- Product Line-up
- Model Explanation
- Servo Motor Features
- Servo Motor Specifications
- Servo Motor Dimensions
- Wiring
- Part Names and Functions
- ASDA-Soft Configuration Software
- Optional Accessories
- Servo Drive Specifications
- Servo Drive Dimensions
- Optional Cables and Connectors
- Servo Drive Accessories Combinations

Cutting-edge Specifications

3.1 kHz Bandwidth

- ▶ Higher responsiveness and shorter settling time could increase productivity.

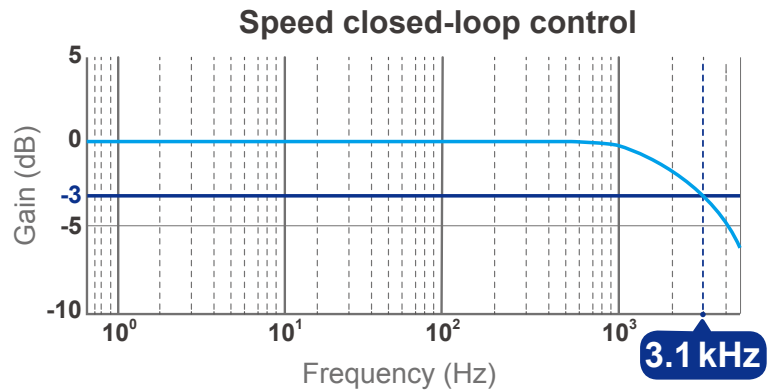
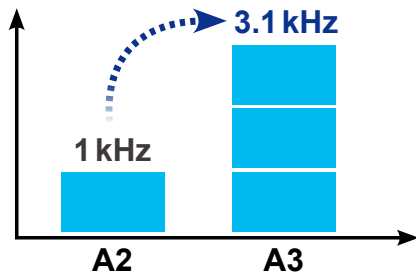

24-bit Absolute Type Encoder

- ▶ The positioning precision is enhanced by the 16,777,216 pulses/turn encoder.
- ▶ The speed variance in low speed is reduced.
- ▶ Absolute type encoder helps to keep motor's position when power is off

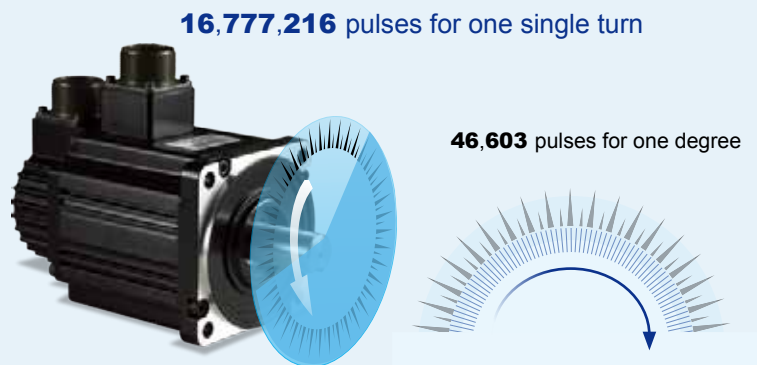

High speed motor with 6000 r/min and 350 % peak torque

- ▶ A3 motor can accelerate and decelerate faster with its design.
- ▶ This specification is available for motor frame size 40 mm, 60 mm and 80mm.

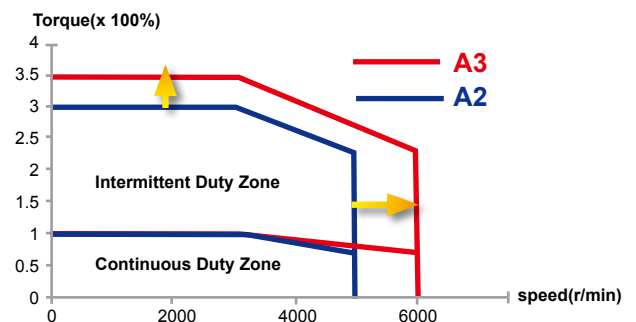
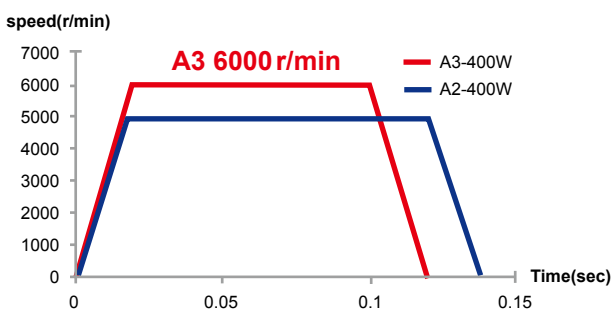

Motor with high or low inertia rotor

- ▶ For application requiring stable rotating speed and better disturbance resistant capability, a high inertia motor is more suitable, such as machine tools.
- ▶ For application like reciprocating motion and fast positioning request, a low inertia motor can be used, such as electronic manufacturing machines.

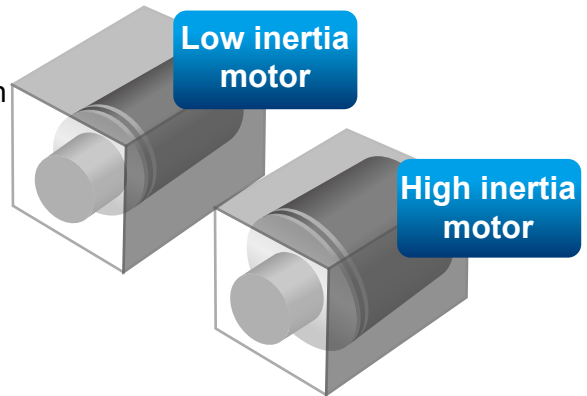

Low Cogging Torque Motor

- Cogging torque of the ECM-A3 motor is only 1.5% of the rated torque, which brings smoother operating speed and increases the stability when machining at low speed.

Cogging Torque (under 1.5%)

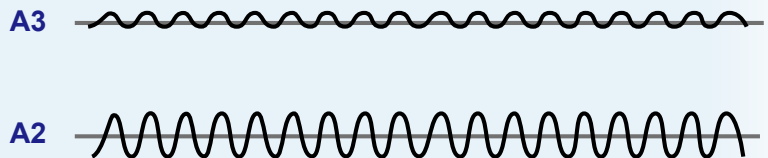

Supports a Variety of Servo Motors

- Backward compatibility design for motor to meet future replacement.
- ASDA-A3 drive can support both A2 (ECMA) and A3 (ECM-A3) series motors.

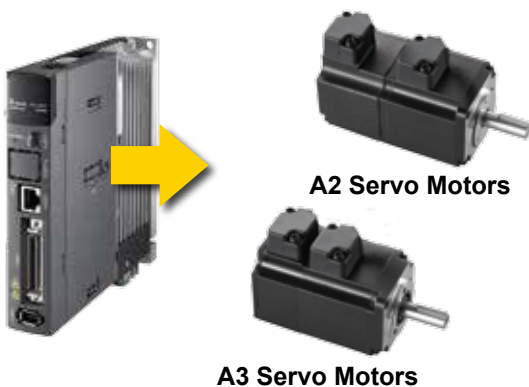

Full-Closed Loop Control

- To ensure the positioning accuracy at the end and eliminate the effect of transmission backlash, full-closed loop control function is an effective solution.

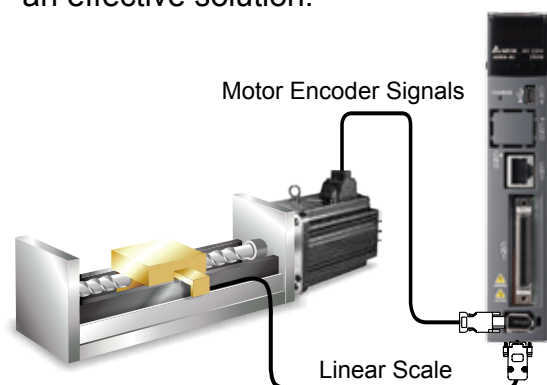

System Tuning and Safety Functions

System Diagnosis Function

- ▶ The rigidity of a machine is known through a mathematical model.
- ▶ The consistency of the machine's batch installation can be checked.
- ▶ By comparing the data from different time span, the wear condition of a machine can be acquired.



Low Frequency Vibration Suppression Function

- ▶ Vibration elimination algorithm is different from command filter and used as a creative algorithm on ASDA-A3.
- ▶ The vibration can be eliminated without slowing down its response.
- ▶ In addition to vibration elimination algorithm, the two command filters for low frequency vibration are included.

Without Vibration Suppression

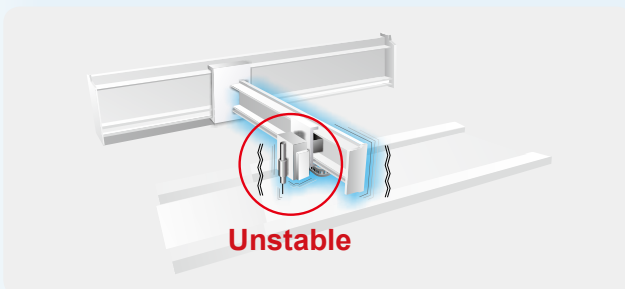

Delta Vibration Suppression

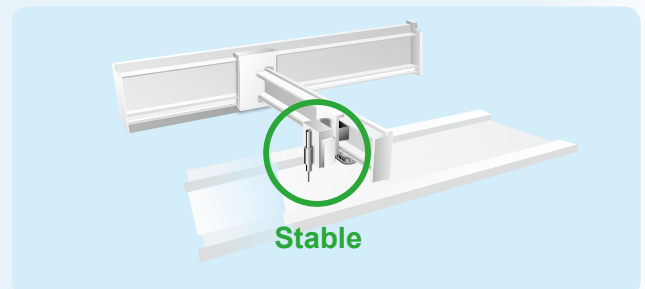

Auto-Tuning Function

- ▶ Lower the barrier for users to use servo systems.
- ▶ This function will optimize the machine performance with less tuning effort.
- ▶ It can be done via panel keypad or software.

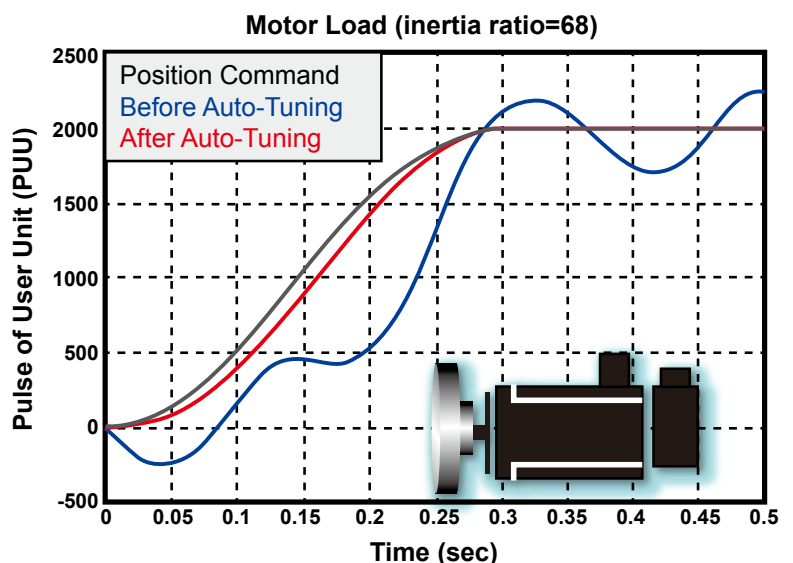

Advanced Notch Filter

- ▶ There are 5 sets of notch filters with tunable bandwidth and up to 5000 Hz band for ASDA-A3.
- ▶ Those filters can search resonance and set the attenuation level automatically.
- ▶ With shorter search time for resonance, the machine is less likely to be damaged.

Test Machine Layout

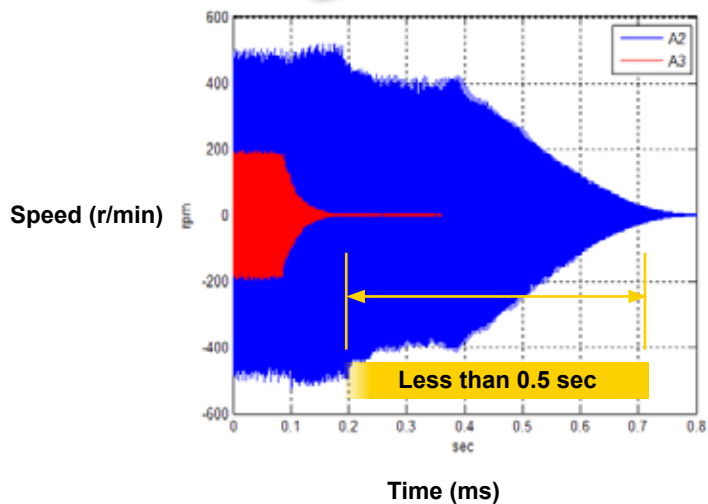
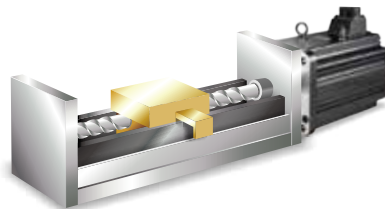

Safe Torque Off (STO) Function **note : will be certified*

- ▶ Built-in STO (Safe Torque Off) function
- ▶ The motor power will be cut-off when STO is activated.

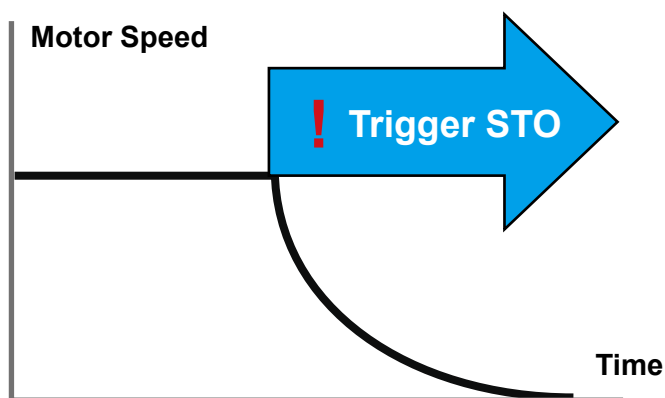
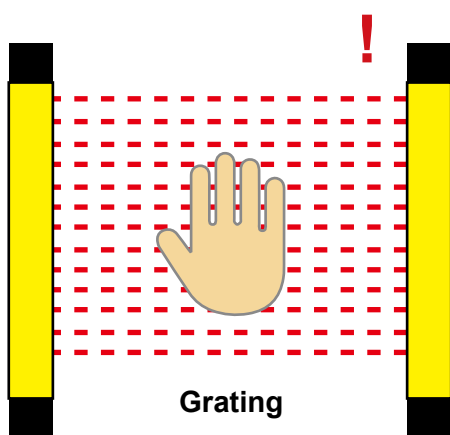

Motion Inside



Motion Inside

- ▶ 99 sophisticated motion commands and segments allowed.
- ▶ Arithmetic operation and condition jump commands are added.
- ▶ Graphical user interface offers simple setup and programming.
- ▶ General motion functions like homing, position and speed commands are available.
- ▶ Superimposition, blending and on-the-fly change motion commands are provided.

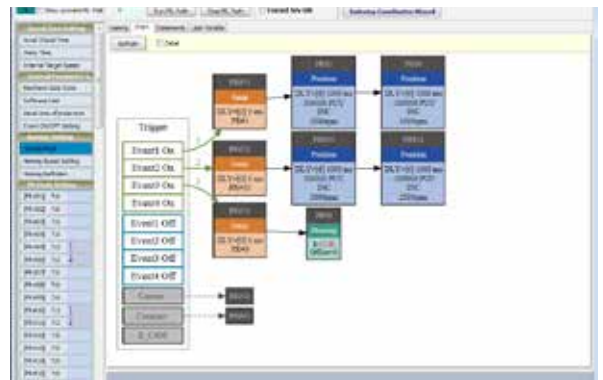

Built-in Camming Functions

- ▶ E-CAM functions for flying shear and rotary cut are well configured.
- ▶ There are maximum 720 points in one cam profile or contour with interpolation smooth algorithm.
- ▶ Useful E-CAM phase secure and adjustment functions are easy to apply.
- ▶ Many successful applications from ASDA-A2 are available for reference.



Capture and Compare Functions

- ▶ It is only 5 μ s response time to latch the position or pulse count after receiving the activated DI single.
- ▶ The high-speed DO will response when assigned position or count value is reached after 5 μ s response time.

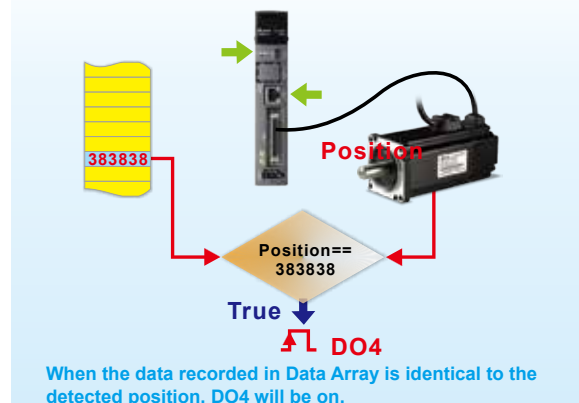
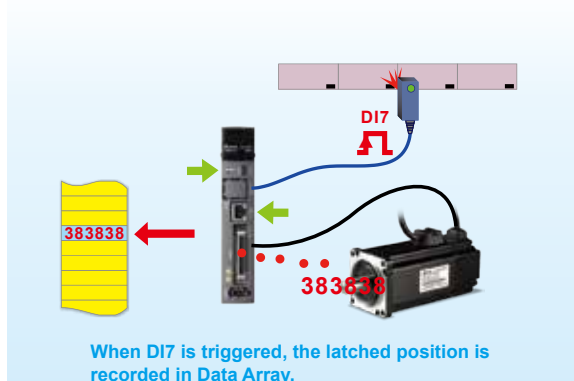

Energy-Saving and Compact Size Design



DC-bus Sharing Feature

- ▶ The regenerative energy will be collected to DC-bus for other axes to increase energy efficiency.
- ▶ Smaller resistor installed is possible for the system, which can save cost and installation space.

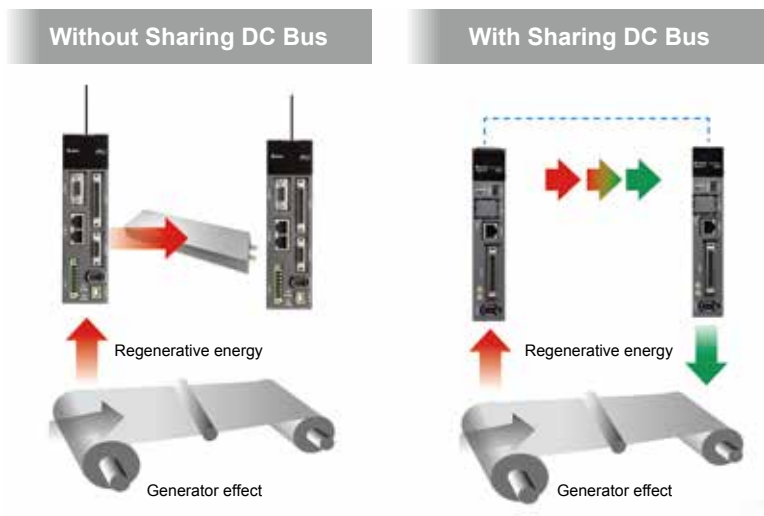

Thinner Size Servo Drive

- ▶ ASDA-A3 is 20% smaller than A2 on dimensions, which requires less installation space.

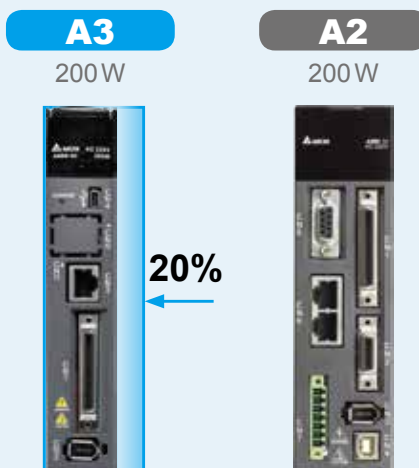

Smaller Size Servo Motor

- ▶ ASDA-A3 series servo motor is 20% shorter than A2's.

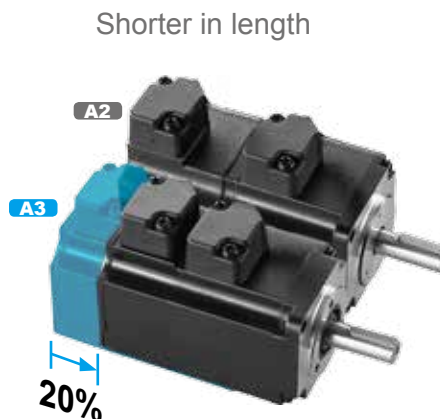

User-Friendly Software



Tree-View Index Window

- ▶ Well organized list and collapsible menu help to access functions easily.

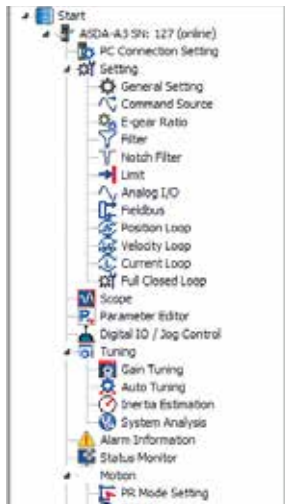

Graphical Interface for Parameter Settings

- ▶ Intuitive user interface provides set up functions and parameters without manual findings.

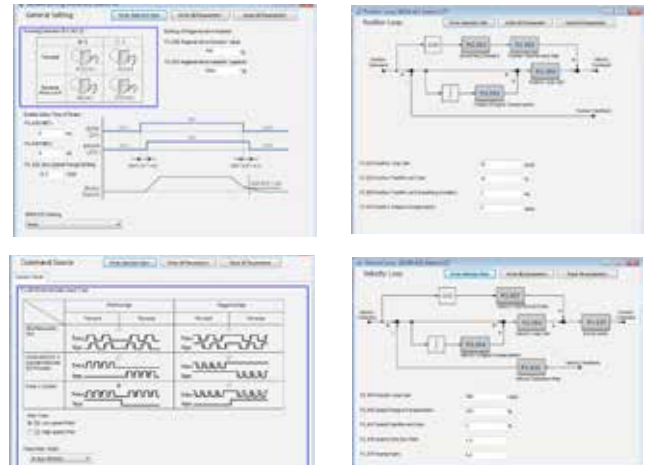

Auto-Tuning Wizard for Gains

- ▶ Provides step by step guiding wizard for users to tune a servo.



Advanced Gain Tuning Interface

- ▶ The servo gains can be easily fine-tuned for better performance with its well-designed tuning modes.



System Analysis in Bode Plot

Speed Open-Loop Mode

Checks the bode plot to know the margin for stability for properly tuned system.

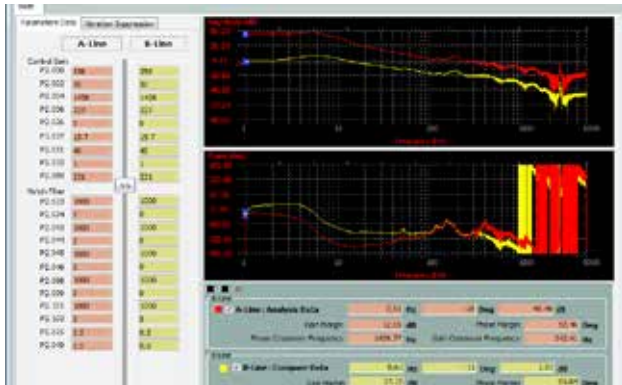

System Module Mode

The machine rigidity can be judged from the bode plot in this mode

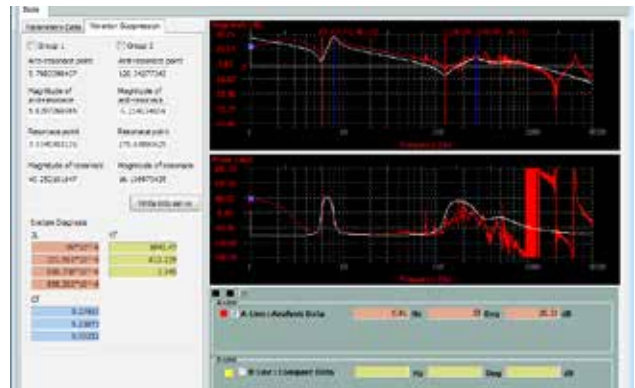

Oscilloscope Function

- ▶ The channel configurations for applying the PC scope include:
 - 8 channels with 16-bit data size and 10 kHz sampling rate.
 - 4 channels with 32-bit data size and 10 kHz sampling rate.
 - 4 channels with 16 bit data size and 20 kHz sampling rate.

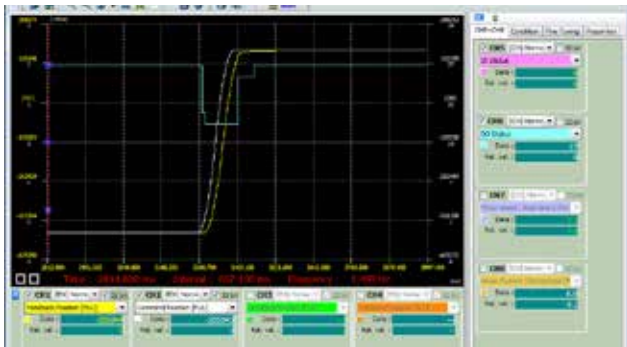

- ▶ Offers FFT (Fast Fourier Transform) function for checking its signal spectrum.
- ▶ The RMS value can be calculated by selecting the period of a signal.
- ▶ The conditions of start-to-record and stop-recording can be configured.



Graphical Programming Interface of PR mode

- ▶ This tool easily allow users to write and trace programs including Jump instructions.

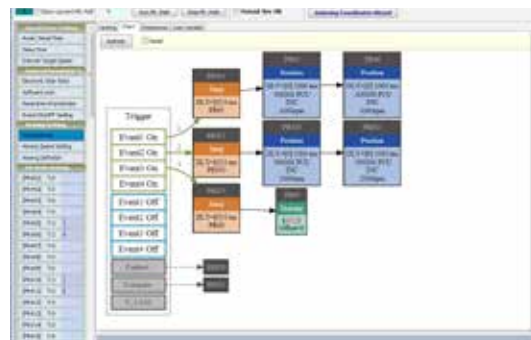

Ordering Information

Product Line Up

Servo Motors							Servo Drives		
Motor Series	Phase	Rated Output Power (W)	Model Name	Rated current (Arms)	Max. current (A)	Model Name	Continuous Output Current (Arms)	Max. Instantaneous Current (A)	
Low Inertia	ECM-A3L 3000 r/min	1-phase / 3-phase	50	ECM-A3L-C [1] 040F [2] [3] 1	0.67	2.62	ASD-A3-0121	0.9	3.54
			100	ECM-A3L-C [1] 0401 [2] [3] 1	0.89	3.5			
			200	ECM-A3L-C [1] 0602 [2] [3] 1	1.45	5.0			
			400	ECM-A3L-C [1] 0604 [2] [3] 1	2.65	8.5			
			400	ECM-A3L-C [1] 0804 [2] [3] 1	2.6	8.6			
			750	ECM-A3L-C [1] 0807 [2] [3] 1	5.1	15.9			
Medium-High Inertia	ECMC-C 3000 r/min	1-phase / 3-phase	1000	ECMC-C [1] 1010 [2] [3]	7.3	21.9	ASD-A3-1021	7.3	24.75
	ECMC-E 2000 r/min		1000	ECMC-E [1] 1310 [2] [3]	5.6	16.8			
		1500	ECMC-E [1] 1315 [2] [3]	8.3	24.9	ASD-A3-1521	8.30	35.36	
		2000	ECMC-E [1] 1320 [2] [3]	11.01	33	ASD-A3-2023	13.40	53.03	
		2000	ECMC-E [1] 1820 [2] [3]	11.22	33.7				
		3000	ECMC-E [1] 1830 [2] [3]	16.1	48.3				
	ECMC-F 1500 r/min	3-phase	3000	ECMC-F [1] 1830 [2] [3]	19.4	58.2	ASD-A3-3023	19.40	70.71
High Inertia	ECM-A3H 3000 r/min	1-phase / 3-phase	50	ECM-A3H-C [1] 040F [2] [3] 1	0.67	2.68	ASD-A3-0121	0.9	3.54
			100	ECM-A3H-C [1] 0401 [2] [3] 1	0.9	3.52			
			200	ECM-A3H-C [1] 0602 [2] [3] 1	1.45	5.4			
			400	ECM-A3H-C [1] 0604 [2] [3] 1	2.65	9.9			
			400	ECM-A3H-C [1] 0804 [2] [3] 1	2.6	9.4			
			750	ECM-A3H-C [1] 0807 [2] [3] 1	4.5	16.6			
	ECMC-F 1500 r/min	1-phase / 3-phase	850	ECMC-F [1] 1308 [2] [3]	7.1	19.4	ASD-A3-1021	7.3	24.75
			1300	ECMC-F [1] 1313 [2] [3]	12.6	38.6	ASD-A3-2023	13.40	53.03
			1800	ECMC-F [1] 1318 [2] [3]	13	36			

Note: In servo motor model names, [1] signifies encoder type, [2] signifies brake or keyway/oil seal, [3] signifies shaft diameter.

Model Explanation

ASDA-A3 Series Servo Drives

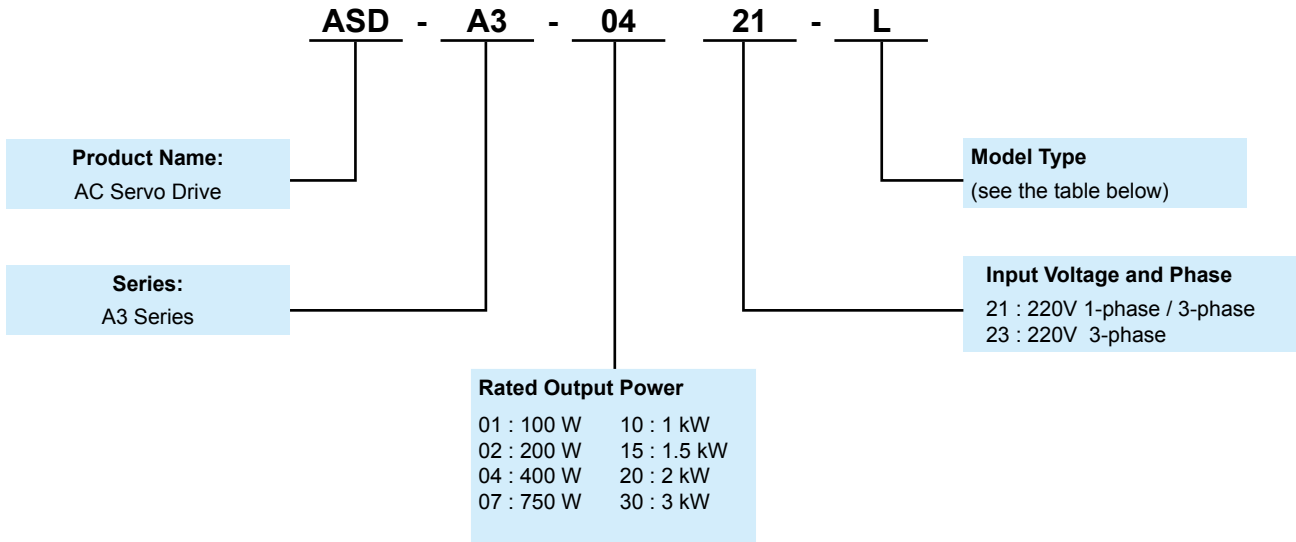

Type	Pulse Input	PR Mode	RS-485	CANopen	Full-Closed Control	Analog Voltage Control	DMCNET	E-CAM	STO
L	○	○	○	X	○	○	X	X	X
M*	○	○	○	○	○	○	X	○	○
F*	X	○	X	X	○	X	○	○	X

Note: Models with a * mark are the ones to be launched.



Model Explanation

ECM-A3 Series Servo Motors

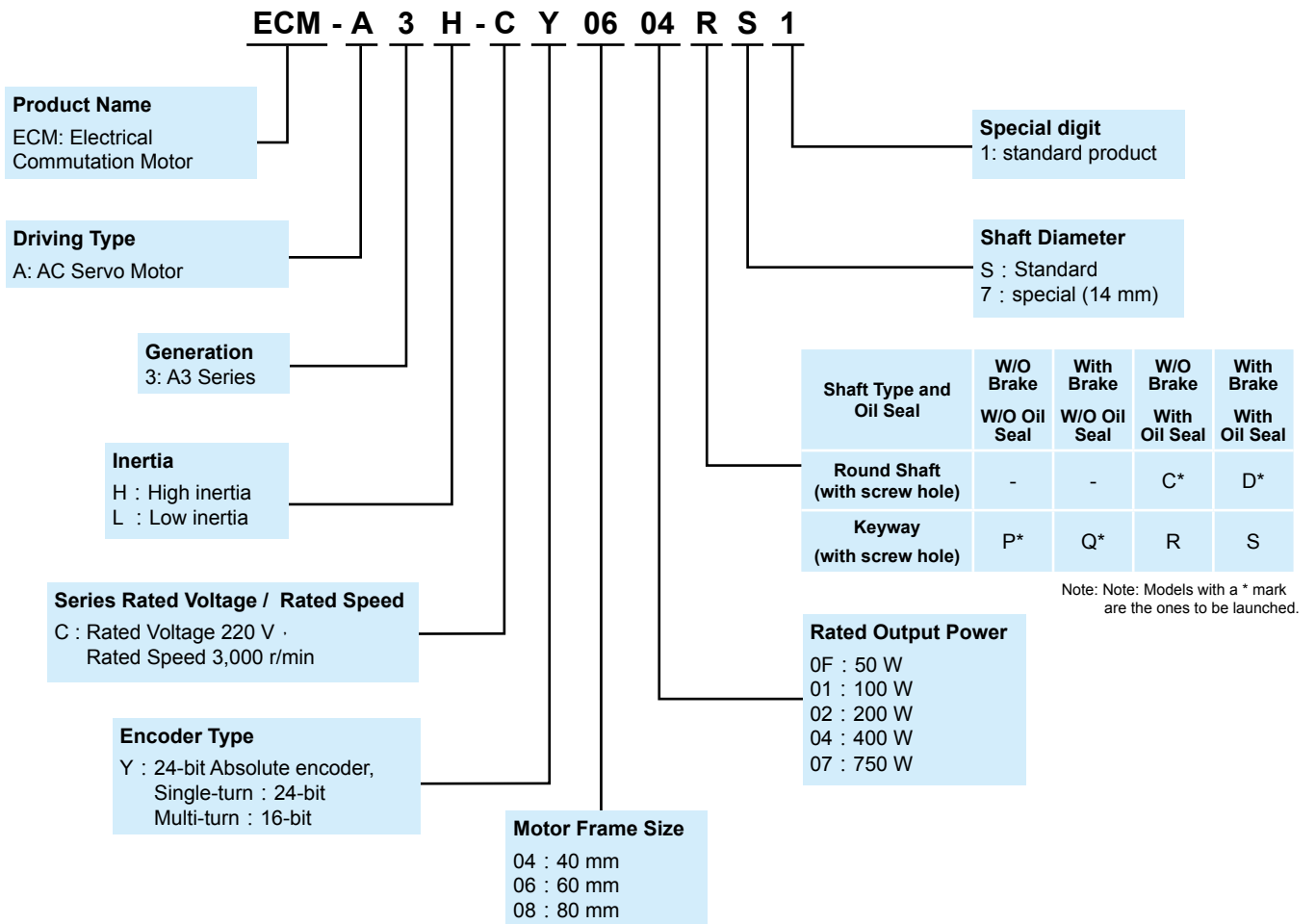

Model Explanation

ECMC Series Servo Motors

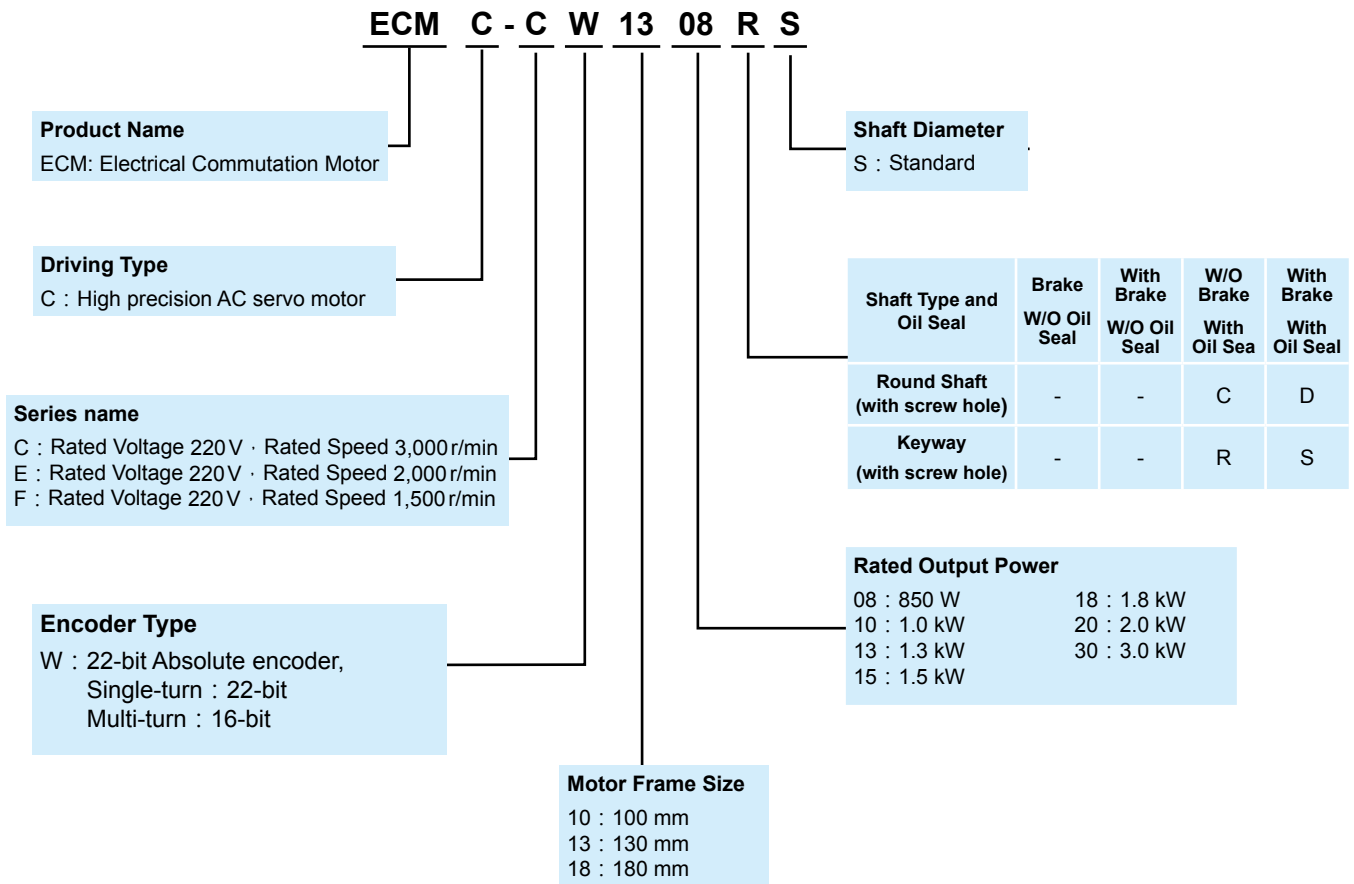

Servo Motor Features

ECM-A3 series servo motor, a high-precision permanent magnet AC servo motor, can be used with ASDA-A3 AC servo drives of 200 ~ 230 V which power is selectable from of 50 W ~ 750 W. Motor frame sizes are 40 mm, 60 mm and 80 mm. Two motor models are available, ECM-A3H high inertia and ECM-A3L low inertia which rated speed is 3000 r/min and the Max. speed is 6000 r/min. The Max. torque of ECM-A3H is 0.557 N-m ~ 8.36 N-m and that of ECM-A3L is 0.557 N-m ~ 7.17 N-m.

ECMC series servo motor, a high precision permanent magnet AC servo motor, can also be applied with ASDA-A3 220 V series servo drive which power range is 850 W ~ 3 kW. Available frame sizes are 100 mm, 130 mm, and 180 mm. Selectable rated torque are 1000 r/min, 2000 r/min, and 3000 r/min while the Max. speed is 3000 r/min and 5000 r/min. And the Max. torque is from 9.54 N-m to 57.3 N-m.

ECM-A3 and ECMC series servo motors provide optional devices, brakes and oil seals, as well as two shaft types, round shaft and keyway.



Servo Motor Specifications

Servo Motor Specifications Low Inertia Series- ECM-A3L

ECM-A3L Series	C104		C106		C108	
	0F	01	02	04	04	07
Rated output power (kW)	0.05	0.1	0.2	0.4	0.4	0.75
Rated torque (N-m) ^{*1}	0.159	0.32	0.64	1.27	1.27	2.39
Maximum torque (N-m)	0.557	1.12	1.92	3.82	3.82	7.17
Rated speed (r/min)	3000					
Maximum speed (r/min)	6000					
Rated current (A)	0.67	0.89	1.45	2.65	2.6	5.1
Maximum current (A)	2.62	3.5	5.0	8.5	8.6	15.9
Power rating (kW/s)	10.9	25.3	45.51	107.5	45.4	111.4
Rotor moment of inertia (x10 ⁻⁴ kg-m ²)(Without a brake)	0.0231	0.0405	0.09	0.15	0.355	0.513
Mechanical time constant (ms)	1.31	0.817	0.64	0.41	0.68	0.405
Torque constant-KT (N-m/A)	0.237	0.36	0.44	0.48	0.49	0.469
Voltage constant-KE (mV/(r/min))	9.28	13.6	16.4	18.0	17.9	17
Armature resistance (Ohm)	11.9	9.47	4.9	2.27	1.6	0.6
Armature inductance (mH)	18.6	16.2	18.52	10.27	10.6	4.6
Electrical time constant (ms)	1.56	1.71	3.78	4.52	6.63	7.67
Insulation class	Class A (UL), Class B (CE)					
Insulation resistance	100 MΩ · DC 500V above					
Insulation strength	1.8k Vac · 1 sec					
Weight (kg)(without brake)	0.38	0.5	1.1	1.4	2.05	2.8
Weight (kg)(with brake)	0.68	0.8	1.6	1.9	2.85	3.6
Max. radial shaft load (N)	78	78	245	245	392	392
Max. thrust shaft load (N)	54	54	74	74	147	147
Power rating (kW/s)(with brake)	10.3	24.5	37.24	89.6	41	95.4
Rotor moment of inertia (x10 ⁻⁴ kg-m ²)(with brake)	0.0246	0.0418	0.12	0.18	0.393	0.599
Mechanical time constant (ms)(with brake)	1.39	0.894	0.88	0.47	0.75	0.47
Brake holding torque [Nt-m (min)] ^{*2}	0.32	0.32	1.3	1.3	2.5	2.5
Brake power consumption (at 20°C)[W]	7.3	7.3	7.2	7.2	8.4	8.4
Brake release time [ms (Max)]	5	5	20	20	20	20
Brake pull-in time [ms (Max)]	25	25	50	50	70	70
Vibration grade (μm)	16					
Operating temperature (°C)	0°C to 40°C					
Storage temperature (°C)	-10°C to 80°C					
Operating humidity	20 to 90%RH (non-condensing)					
Storage humidity	20 to 90%RH (non-condensing)					
Vibration capacity	2.5G					
IP Rating	IP65 (when waterproof connectors are used, or when an oil seal is used to be fitted to the rotating shaft (an oil seal model is used))					
Approvals						

Note:

1. The rated torque is the permissible continuous torque at the operation temperature of 0~40°C when the following heat sink is applied:

ECM-A3: __04/06/ 08 : 250 mm x 250mm x 6mm

Material type: Aluminum- F60, F80

2. The built-in brake of the servo motor is for calmping the shaft. Never use it for decelerating or stopping the motor.

Servo Motor Specifications

High Inertia Series- ECM-A3H

ECM-A3H Series	C104		C106		C108	
	0F	01	02	04	04	07
Rated output power (kW)	0.05	0.1	0.2	0.4	0.4	0.75
Rated torque (N-m) ¹	0.159	0.32	0.64	1.27	1.27	2.39
Maximum torque (N-m)	0.557	1.12	2.24	4.45	4.44	8.36
Rated speed (r/min)	3000					
Maximum speed (r/min)	6000					
Rated current (A)	0.67	0.9	1.45	2.65	2.6	4.5
Maximum current (A)	2.68	3.52	5.4	9.9	9.4	16.6
Power rating (kW/s)	5.89	13.8	16.4	35.8	17.5	37.8
Rotor moment of inertia (x10 ⁻⁴ kg-m ²)(Without a brake)	0.043	0.0742	0.25	0.45	0.92	1.51
Mechanical time constant (ms)	2.49	1.38	1.37	0.96	1.31	0.91
Torque constant-KT (N-m/A)	0.237	0.356	0.44	0.48	0.49	0.53
Voltage constant-KE (mV/(r/min))	9.54	13.2	16.4	17.2	17.9	18.7
Armature resistance (Ohm)	12.5	8.34	3.8	1.68	1.19	0.57
Armature inductance (mH)	13.3	11	8.15	4.03	4.2	2.2
Electrical time constant (ms)	1.07	1.32	2.14	2.40	3.53	3.86
Insulation class	Class A (UL), Class B (CE)					
Insulation resistance	100 MΩ · DC 500V above					
Insulation strength	1.8k Vac · 1 sec					
Weight (kg)(without brake)	0.38	0.5	1.1	1.4	2.05	2.8
Weight (kg)(with brake)	0.68	0.8	1.6	1.9	2.85	3.6
Max. radial shaft load (N)	78	78	245	245	392	392
Max. thrust shaft load (N)	54	54	74	74	147	147
Power rating (kW/s)(with brake)	5.68	13.6	15.17	34.32	15.1	34.4
Rotor moment of inertia (x10 ⁻⁴ kg-m ²)(with brake)	0.0446	0.0755	0.28	0.48	1.07	1.66
Mechanical time constant (ms)(with brake)	2.58	1.4	1.52	1.01	1.53	1
Brake holding torque [Nt-m (min)] ²	0.32	0.32	1.3	1.3	2.5	2.5
Brake power consumption (at 20°C)[W]	7.3	7.3	7.2	7.2	8.4	8.4
Brake release time [ms (Max)]	5	5	20	20	20	20
Brake pull-in time [ms (Max)]	25	25	50	50	70	70
Vibration grade (μm)	15					
Operating temperature (°C)	0°C to 40°C					
Storage temperature (°C)	-10°C to 80°C					
Operating humidity	20 to 90%RH (non-condensing)					
Storage humidity	20 to 90%RH (non-condensing)					
Vibration capacity	2.5G					
IP Rating	IP65 (when waterproof connectors are used, or when an oil seal is used to be fitted to the rotating shaft (an oil seal model is used))					
Approvals						

Note:

1. The rated torque is the permissible continuous torque at the operation temperature of 0~40 °C when the following heat sink is applied:

ECM-A3:___04/06/ 08 : 250 mm x 250mm x 6mm

Material type: Aluminum- F60, F80

2. The built-in brake of the servo motor is for calmping the shaft. Never use it for decelerating or stopping the motor.

Servo Motor Specifications

Medium Inertia ECMC Series- Frame Sizes 100~180 mm

ECMC Series	C □ 10	E □ 13			E □ 18		F □ 18
	10	10	15	20	20	30	30
Rated output power (kW)	1.0	1.0	1.5	2.0	2.0	3.0	3.0
Rated torque (N-m) ¹	3.18	4.77	7.16	9.55	9.55	14.32	19.10
Maximum torque (N-m)	9.54	14.3	21.5	28.7	28.7	43	57.3
Rated speed (r/min)	3000	2000		2000		1500	
Maximum speed (r/min)	5000	3000		3000		3000	
Rated current (A)	7.3	5.6	8.3	11.01	11.2	16.1	19.4
Maximum current (A)	21.9	16.8	24.9	33	33.7	48.3	58.2
Power rating (kW/s)	38.1	27.1	45.9	62.5	26.3	37.3	66.4
Rotor moment of inertia (x10 ⁻⁴ kg-m ²)(Without a brake)	2.65	8.41	11.2	14.6	34.7	55	55
Mechanical time constant (ms)	0.74	1.51	1.10	0.96	1.62	1.06	1.28
Torque constant-KT (N-m/A)	0.44	0.85	0.87	0.87	0.85	0.89	0.98
Voltage constant-KE (mV/(r/min))	16.8	31.9	31.8	31.8	31.4	32.0	35
Armature resistance (Ohm)	0.20	0.47	0.26	0.174	0.119	0.052	0.077
Armature inductance (mH)	1.81	5.99	4.01	2.76	2.84	1.38	1.27
Electrical time constant (ms)	9.3	12.9	15.3	15.9	23.9	26.4	16.5
Insulation class	Class A (UL), Class B (CE)						
Insulation resistance	100 MΩ · DC 500 V above						
Insulation strength	1.8k Vac · 1sec						
Weight (kg)(without brake)	4.3	7.0	7.5	7.8	13.5	18.5	18.5
Weight (kg)(with brake)	4.7	8.4	8.9	9.2	17.5	22.5	22.5
Max. radial shaft load (N)	490			1176		1470	
Max. thrust shaft load (N)	98					490	
Power rating (kW/s)(with brake)	30.4	24.9	43.1	57.4	24.1	35.9	63.9
Rotor moment of inertia (x10 ⁻⁴ kg-m ²)(with brake)	3.33	9.14	11.9	15.9	37.8	57.1	57.1
Mechanical time constant (ms)(with brake)	0.93	1.64	1.19	1.05	1.77	1.10	1.33
Brake holding torque [Nt-m (min)] ²	8	10			25		
Brake power consumption (at 20°C)[W]	18.7	19			20.4		
Brake release time [ms (Max)]	10						
Brake pull-in time [ms (Max)]	70						
Vibration grade (μm)	V15						
Operating temperature (°C)	0°C ~ 40°C (32°F ~ 104°F)						
Storage temperature (°C)	-10°C ~ 80°C (-14°F ~ 176°F)						
Operating humidity	20 to 90%RH (non-condensing)						
Storage humidity	20 to 90%RH (non-condensing)						
Vibration capacity	2.5G						
IP Rating	IP65 (when waterproof connectors are used, or when an oil seal is used to be fitted to the rotating shaft (an oil seal model is used))						
Approvals							

Note:
 1. □ in the servo model name signifies encoder type.
 2. The rated torque is the permissible continuous torque at the operation temperature of 0~40 °C when the following heat sink is applied:
 ECMC-□10 : 300 mm x 300 mm x 12 mm
 ECMC-□13 : 400 mm x 400 mm x 20 mm
 ECMC-□18 : 550 mm x 550 mm x 30 mm
 Material type: Aluminum- F60, F80
 3. The built-in brake of the servo motor is for calmping the shaft. Never use it for decelerating or stopping the motor.

Servo Motor Specifications

High Inertia ECMC Series-Frame Sizes 130 mm

ECMC Series	F 13		
	08	13	18
Rated output power (kW)	0.85	1.3	1.8
Rated torque (N-m) ¹	5.41	8.34	11.48
Maximum torque (N-m)	13.8	23.3	28.7
Rated speed (r/min)	1500		
Maximum speed (r/min)	3000		
Rated current (A)	7.1	12.6	13
Maximum current (A)	19.4	38.6	36
Power rating (kW/s)	21.52	34.78	53
Rotor moment of inertia (x10 ⁻⁴ kg-m ²)(Without a brake)	13.6	20	24.9
Mechanical time constant (ms)	2.43	1.62	1.7
Torque constant-KT (N-m/A)	0.76	0.66	0.88
Voltage constant-KE (mV/(r/min))	29.2	24.2	32.2
Armature resistance (Ohm)	0.38	0.124	0.185
Armature inductance (mH)	4.77	1.7	2.6
Electrical time constant (ms)	12.6	13.7	14.1
Insulation class	Class A (UL), Class B (CE)		
Insulation resistance	100 MΩ · DC 500V above		
Insulation strength	1.8k Vac · 1 sec		
Weight (kg)(without brake)	8.6	9.4	10.5
Weight (kg)(with brake)	10	10.8	11.9
Max. radial shaft load (N)	490		
Max. thrust shaft load (N)	98		
Power rating (kW/s)(with brake)	19.8	32.7	50.3
Rotor moment of inertia (x10 ⁻⁴ kg-m ²)(with brake)	14.8	21.3	26.2
Mechanical time constant (ms)(with brake)	2.65	1.73	1.79
Brake holding torque [Nt-m (min)] ²	10		
Brake power consumption (at 20°C)[W]	19		
Brake release time [ms (Max)]	10		
Brake pull-in time [ms (Max)]	70		
Vibration grade (μm)	V15		
Operating temperature (°C)	0°C ~ 40°C (32°F ~ 104°F)		
Storage temperature (°C)	-10°C ~ 80°C (-14°F ~ 176°F)		
Operating humidity	20 ~ 90%RH (non-condensing)		
Storage humidity	20 ~ 90%RH (non-condensing)		
Vibration capacity	2.5 G		
IP Rating	IP65 (when waterproof connectors are used, or when an oil seal is used to be fitted to the rotating shaft (an oil seal model is used))		
Approvals			

Note:

- In the servo model name signifies encoder type.
- The rated torque is the permissible continuous torque at the operation temperature of 0~40 °C when the following heat sink is applied:
 ECMC-__10 : 300 mm x 300 mm x 12 mm
 ECMC-__13 : 400 mm x 400 mm x 20 mm
 ECMC-__18 : 550 mm x 550 mm x 30 mm
 Material type: Aluminum- F100, F130, F180
- The built-in brake of the servo motor is for calmping the shaft. Never use it for decelerating or stopping the motor.

Servo Motor Dimensions

ECM-A3 Series

Frame Size 80 mm and below

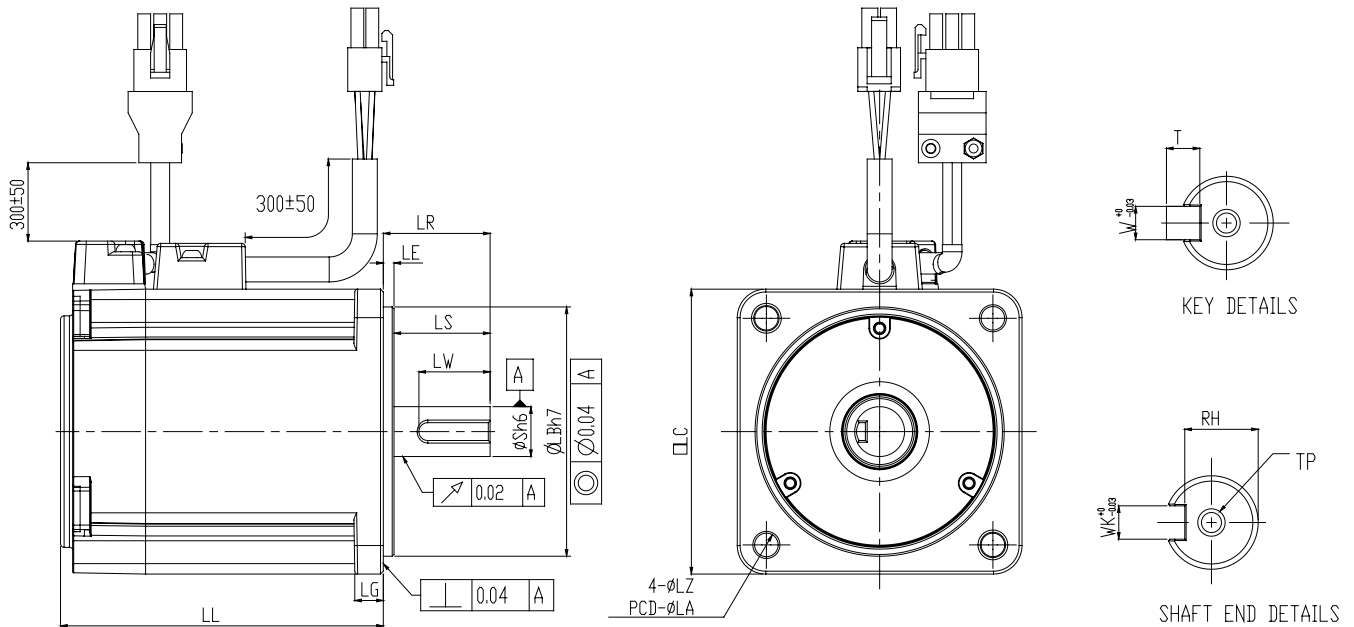

Units: mm

Model	C □ 040F □ S □	C □ 0401 □ S □	C □ 0602 □ S □	C □ 0604 □ S □	C □ 0804 □ 7 □	C □ 0807 □ S □
LC	40	40	60	60	80	80
LZ	4.5	4.5	5.5	5.5	6.6	6.6
LA	46	46	70	70	90	90
S	8 (+0 / -0.009)	8 (+0 / -0.009)	14 (+0 / -0.011)	14 (+0 / -0.011)	14 (+0 / -0.011)	19 (+0 / -0.013)
LB	30 (+0 / -0.021)	30 (+0 / -0.021)	50 (+0 / -0.025)	50 (+0 / -0.025)	70 (+0 / -0.03)	70 (+0 / -0.03)
LL(with out brake)	70.6	85.3	84	106	93.7	115.8
LL(with brake)	105.4	120.1	117.6	139.7	131.2	153.2
LS	21.5	22.5	27	27	27	37
LR	25	25	30	30	30	40
LE	2.5	2.5	3	3	3	3
LG	5	5	7.5	7.5	8	8
LW	16	16	20	20	20	25
RH	6.2	6.2	11	11	11	15.5
WK	3	3	5	5	5	6
W	3	3	5	5	5	6
T	3	3	5	5	5	6
TP	M3 Depth 6	M3 Depth 6	M4 Depth 8	M4 Depth 8	M4 Depth 8	M6 Depth 10

Note: Note: In servo motor model names, □ signifies encoder type, □ signifies shaft diameter and oil seal, and □ signifies special code

Speed-Torque Curves (T-N Curves)

ECM-A3 Torque Features

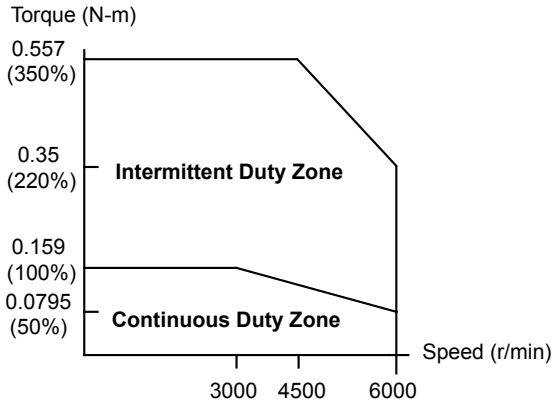

ECM-A3L-CΔ04F□S1

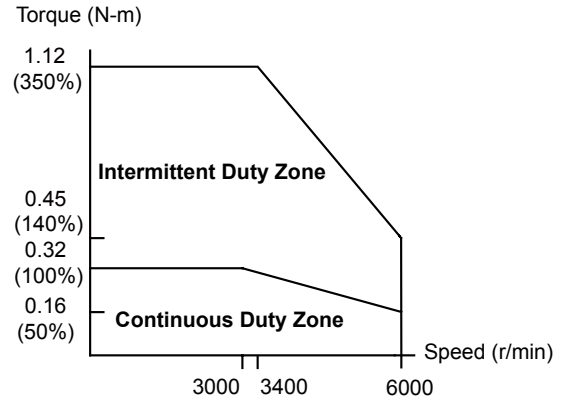

ECM-A3L-CΔ401□S1

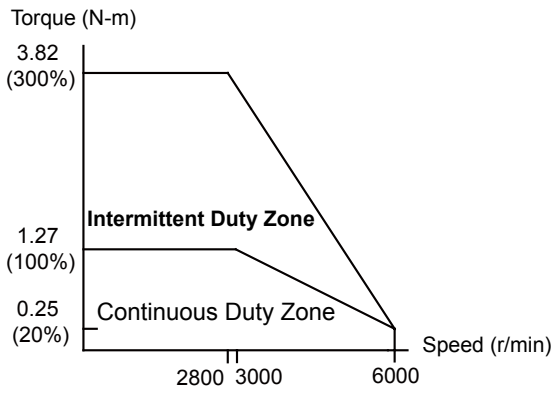

ECM-A3L-CΔ0604□S1

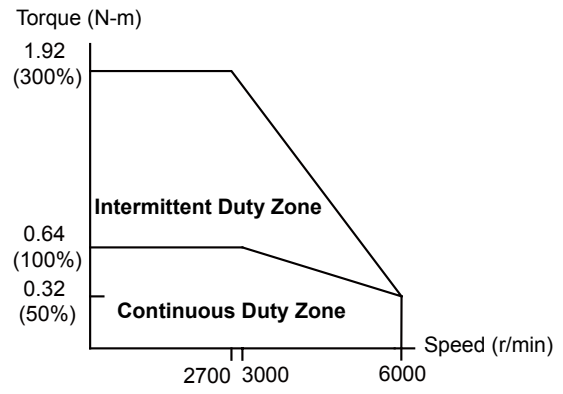

ECM-A3L-CΔ0602□S1

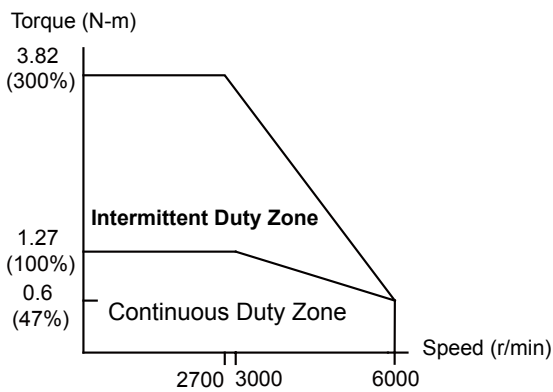

ECM-A3L-CΔ0804□S1

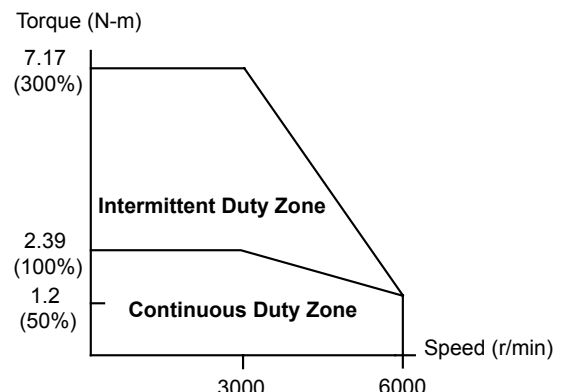

ECM-A3L-CΔ0807□S1

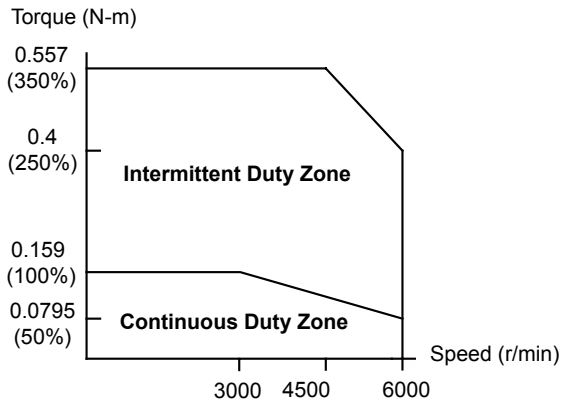

ECM-A3H-CΔ040F□S1

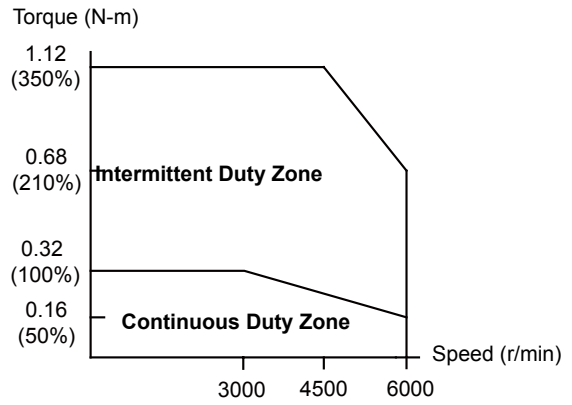

ECM-A3H-CΔ0401□S1

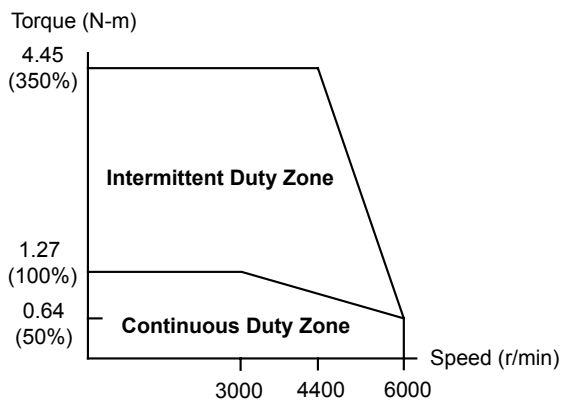

ECM-A3H-CΔ0604□S1

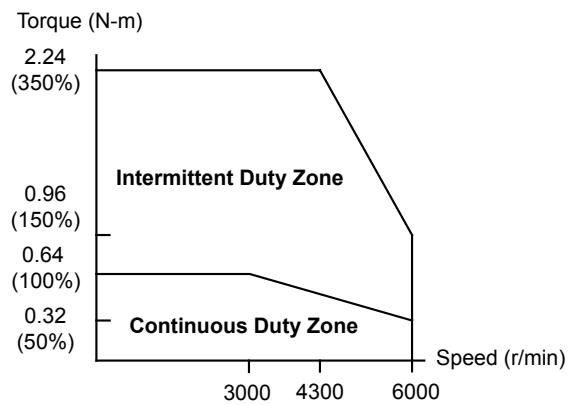

ECM-A3H-CΔ0602□S1

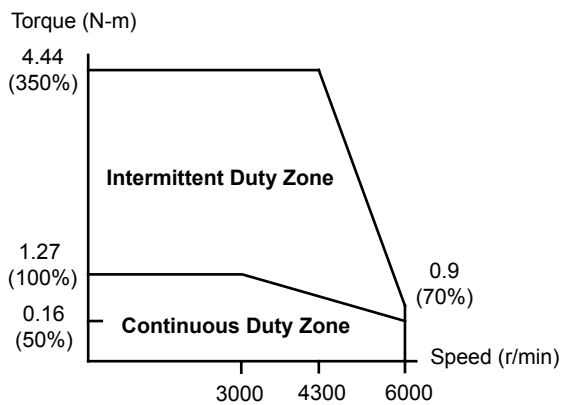

ECM-A3H-CΔ0804□S1

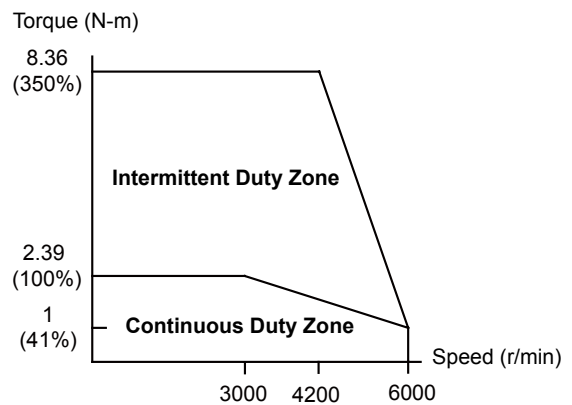

ECM-A3H-CΔ0807□S1

Servo Motor Dimensions

ECMC Series

Frame Sizes 100 / 130 mm

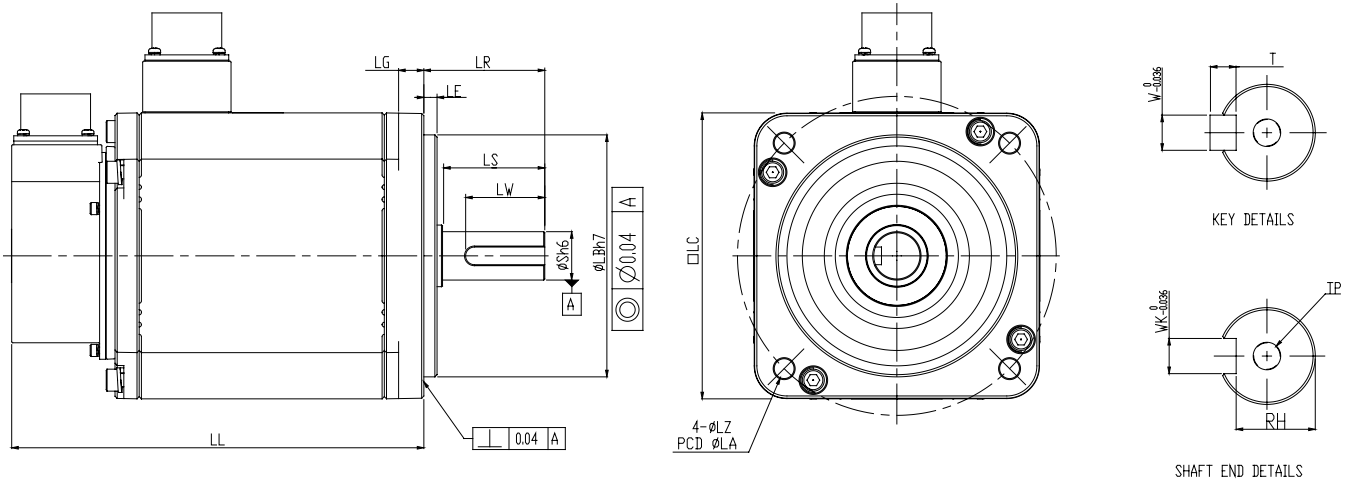

Units: mm

Model	C □ 1010 □ S	E □ 1310 □ S	E □ 1315 □ S	E □ 1320 □ S	F □ 1308 □ S	F □ 1313 □ S	F □ 1318 □ S
LC	100	130	130	130	130	130	130
LZ	9	9	9	9	9	9	9
LA	115	145	145	145	145	145	145
S	22 (+0 / -0.013)	22 (+0 / -0.013)	22 (+0 / -0.013)	22 (+0 / -0.013)	22 (+0 / -0.013)	22 (+0 / -0.013)	22 (+0 / -0.013)
LB	95 (+0 / -0.035)	110 (+0 / -0.035)	110 (+0 / -0.035)	110 (+0 / -0.035)	110 (+0 / -0.035)	110 (+0 / -0.035)	110 (+0 / -0.035)
LL(with out brake)	153.3	147.5	167.5	187.5	152.5	187.5	202
LL(with brake)	192.5	183.5	202	216	181	216	230.7
LS	37	47	47	47	47	47	47
LR	45	55	55	55	55	55	55
LE	5	6	6	6	6	6	6
LG	12	11.5	11.5	11.5	11.5	11.5	11.5
LW	32	36	36	36	36	36	36
RH	18	18	18	18	18	18	18
WK	8	8	8	8	8	8	8
W	8	8	8	8	8	8	8
T	7	7	7	7	7	7	7
TP	M6 Depth 20	M6 Depth 20	M6 Depth 20	M6 Depth 20	M6 Depth 20	M6 Depth 20	M6 Depth 20

Note: Note: In servo motor model names, □ signifies encoder type, □ signifies shaft diameter and oil seal, and □ signifies special code

Servo Motor Dimensions

ECMC Series

Frame Size 180 mm

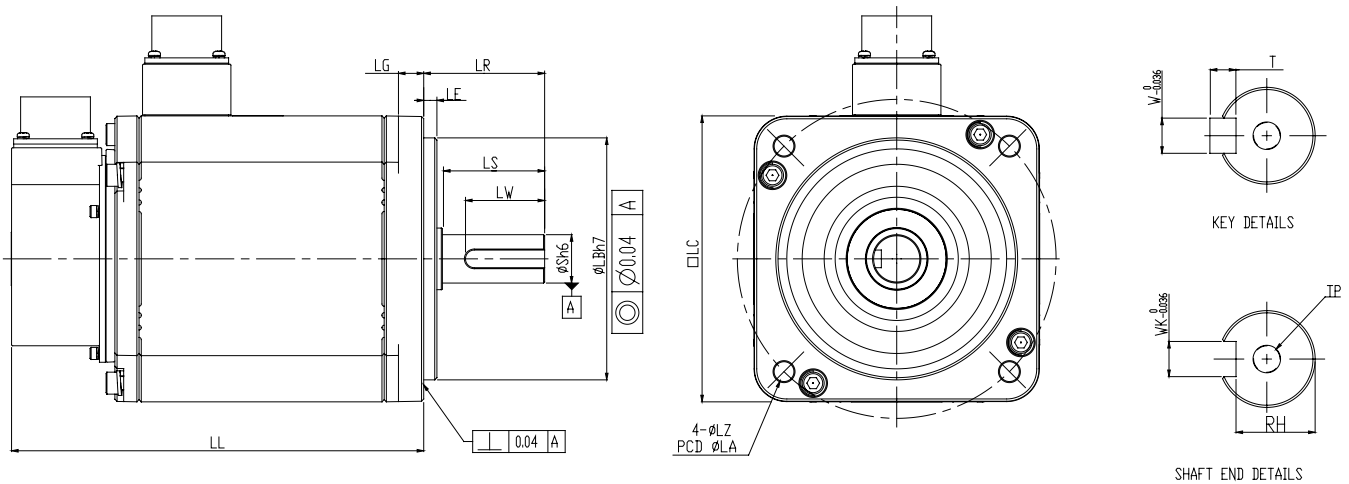

Units: mm

Model	E □ 1820 □ □ □	E □ 1830 □ □ □	F □ 1830 □ □ □
LC	180	180	180
LZ	13.5	13.5	13.5
LA	200	200	200
S	35 ⁺⁰ / _{-0.016}	35 ⁺⁰ / _{-0.016}	35 ⁺⁰ / _{-0.016}
LB	114.3 ⁺⁰ / _{-0.035}	114.3 ⁺⁰ / _{-0.035}	114.3 ⁺⁰ / _{-0.035}
LL(with out brake)	169	202.1	202.1
LL(with brake)	203.1	235.3	235.3
LS	73	73	73
LR	79	79	79
LE	4	4	4
LG	20	20	20
LW	63	63	63
RH	30	30	30
WK	10	10	10
W	10	10	10
T	8	8	8
TP	M12 Depth 25	M12 Depth 25	M12 Depth 25

Note: In servo motor model names, □ signifies encoder type, □ signifies shaft diameter and oil seal, and □ signifies special code

Speed-Torque Curves (T-N Curves)

ECMC Torque Features

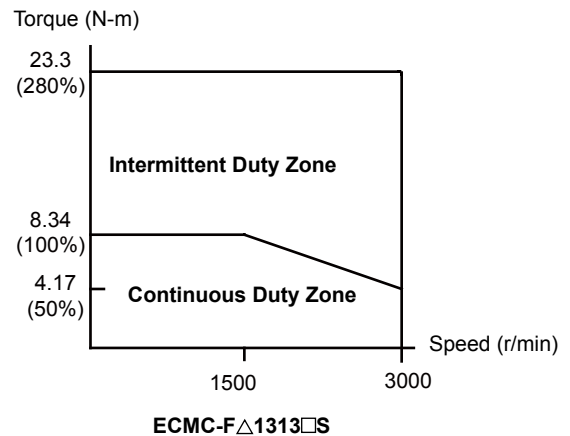
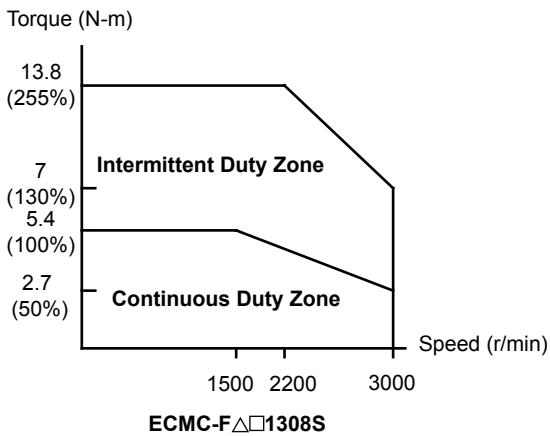
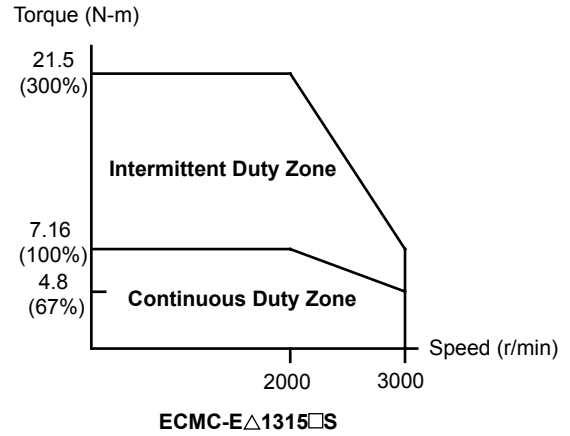
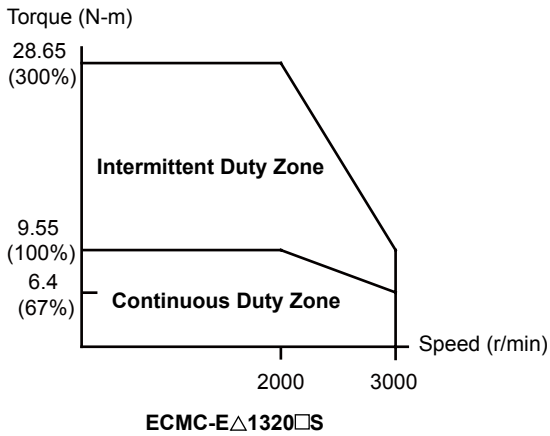
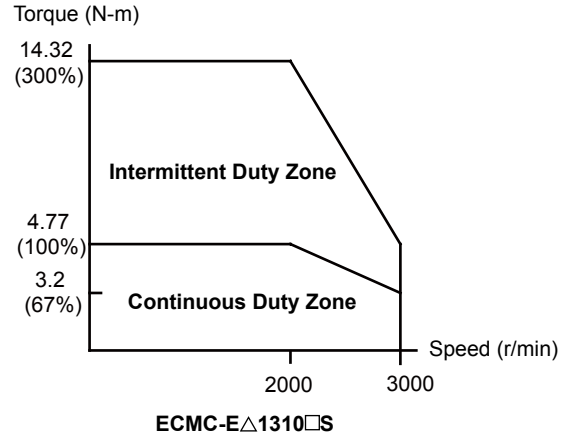
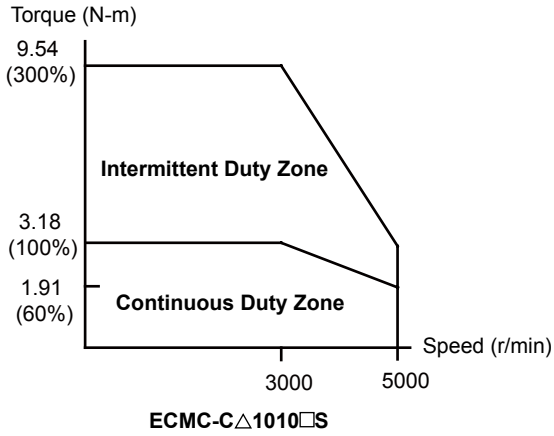

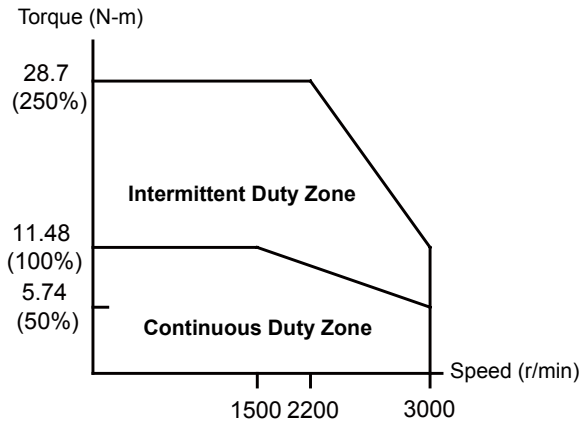

ECMC-FΔ1318□S

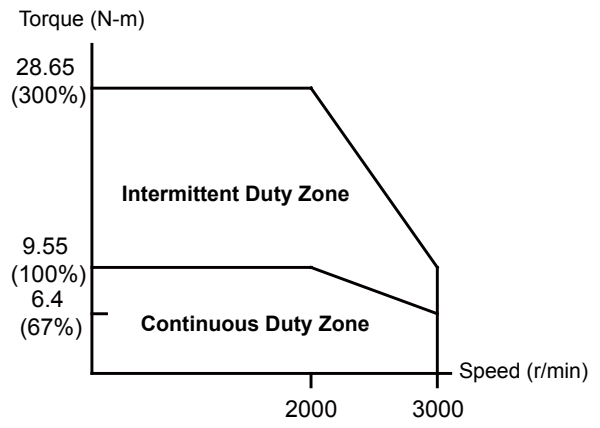

ECMC-E Δ□1820S

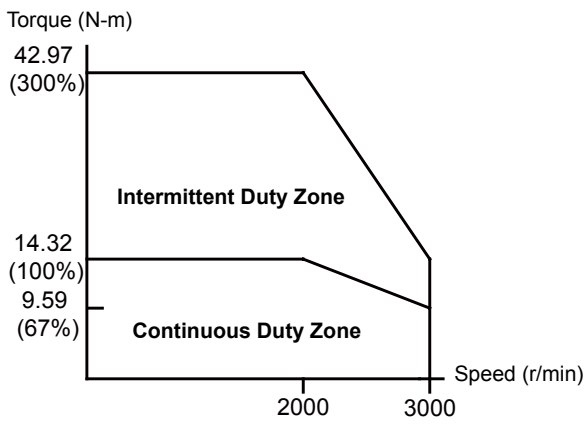

ECMC-E Δ1830□S

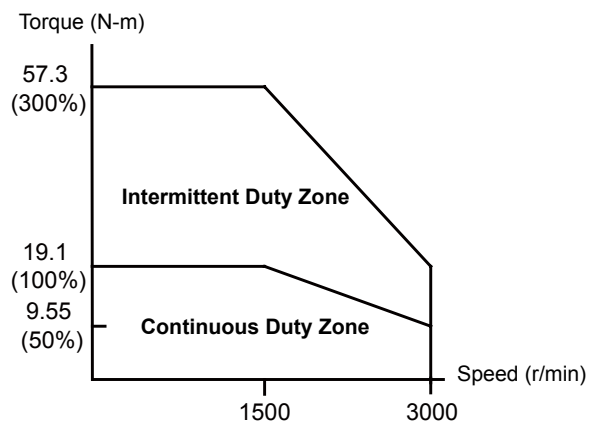

ECMC-FΔ1830□S

Wiring

Position (PT) Control Mode (for pulse command input)

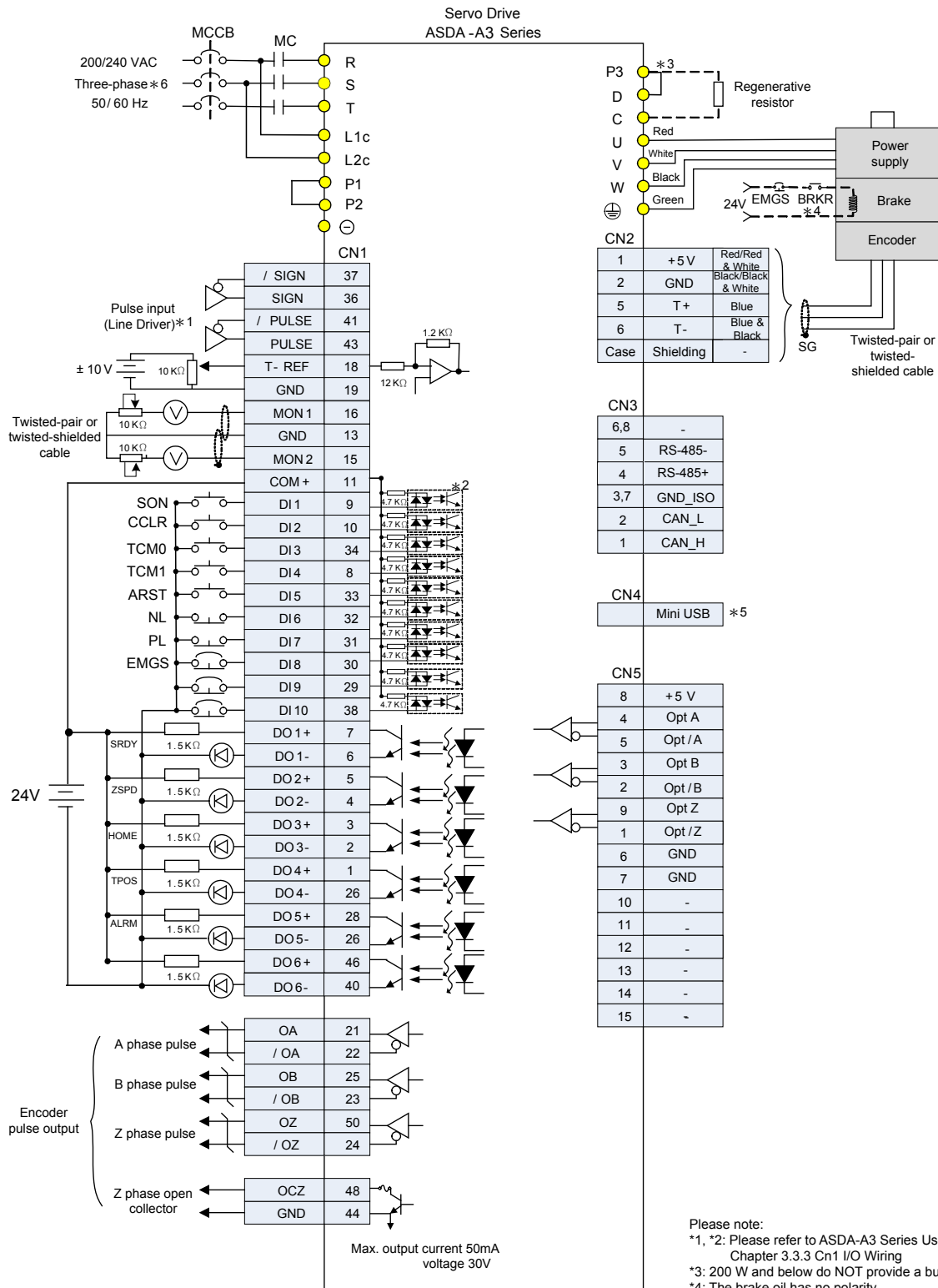

Position (PR) Control Mode (for Internal Procedure Control)

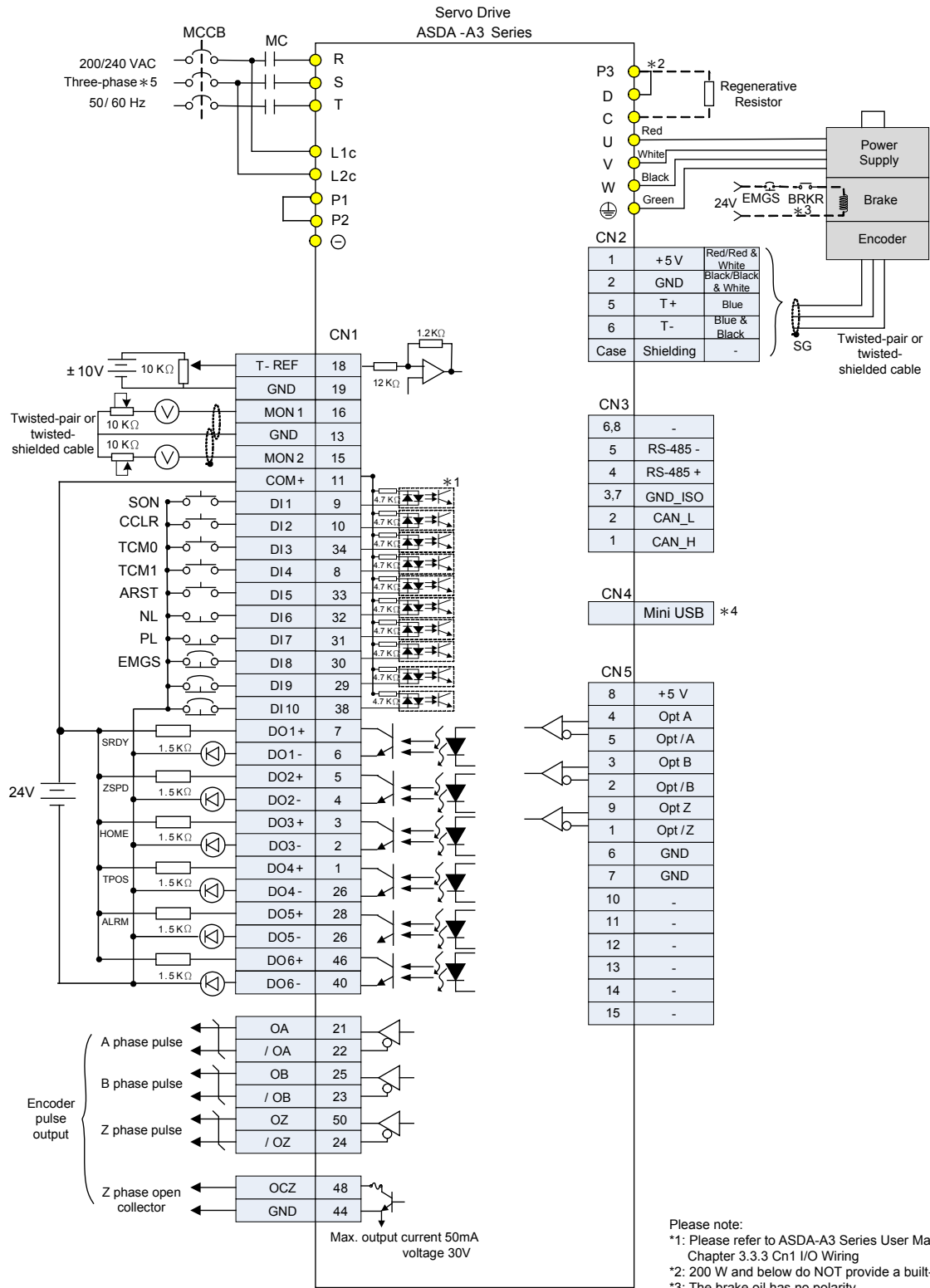

Please note:
 *1: Please refer to ASDA-A3 Series User Manual, Chapter 3.3.3 Cn1 I/O Wiring
 *2: 200 W and below do NOT provide a built-in regenerative resistor
 *3: The brake oil has no polarity
 *4: Connect to Mini-USB of PC
 *5: Single-phase connections are for servo drives 1.5kW and below only

Wiring

Torque (T) Mode Standard Wiring (for Analog Voltage Input and Internal Parameter Setting)

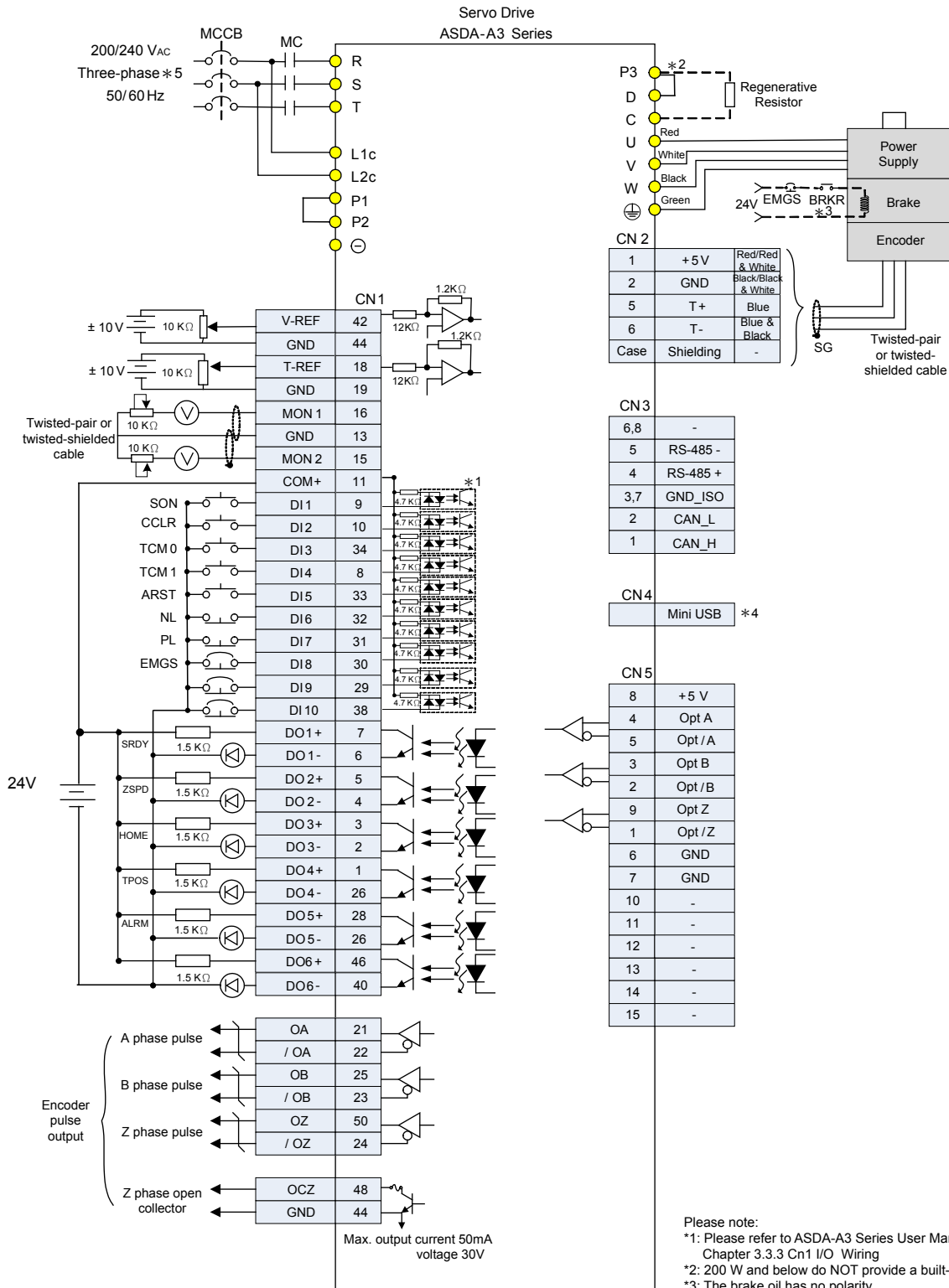

Speed (S) Mode (for Analog Voltage Input and Internal Parameter Setting)

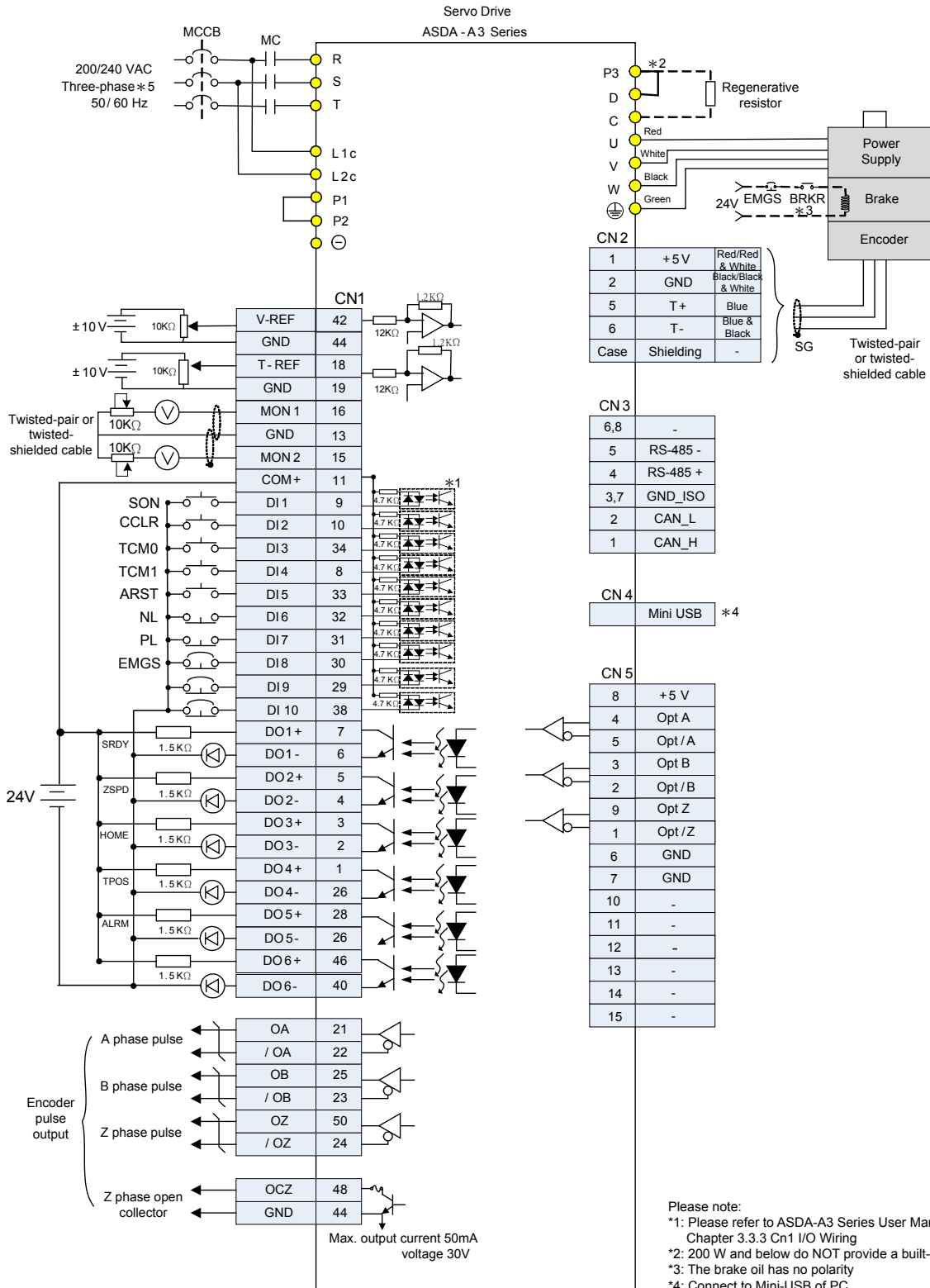

Wiring

Communication mode (CANopen)

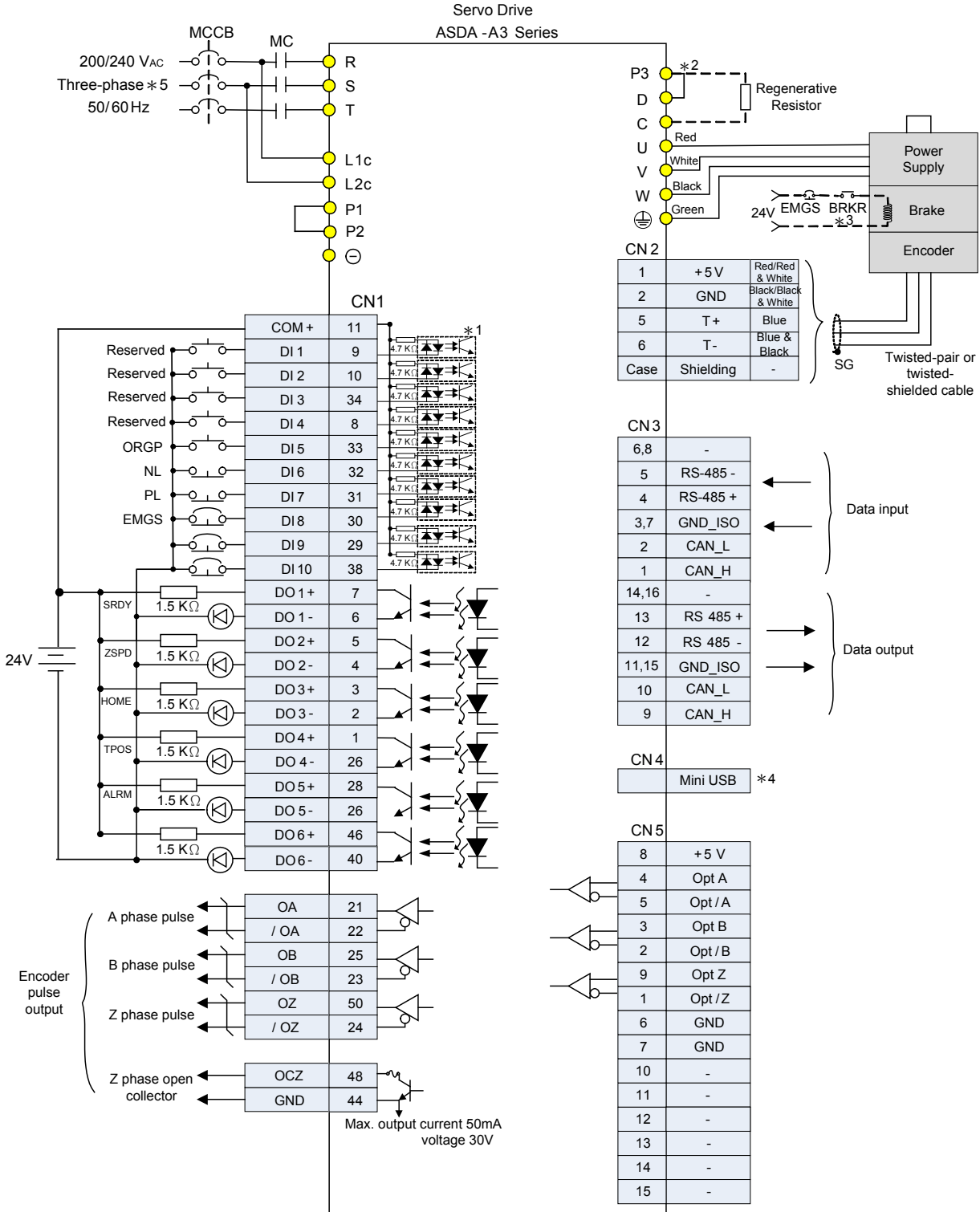

Please note:

*1: Please refer to ASDA-A3 Series User Manual, Chapter 3.3.3 Cn1 I/O Wiring

*2: 200 W and below do NOT provide a built-in regenerative resistor

*3: The brake oil has no polarity

*4: Connect to Mini-USB of PC

*5: Single-phase connections are for servo drives 1.5kW and below only

Communication mode (DMCNET)

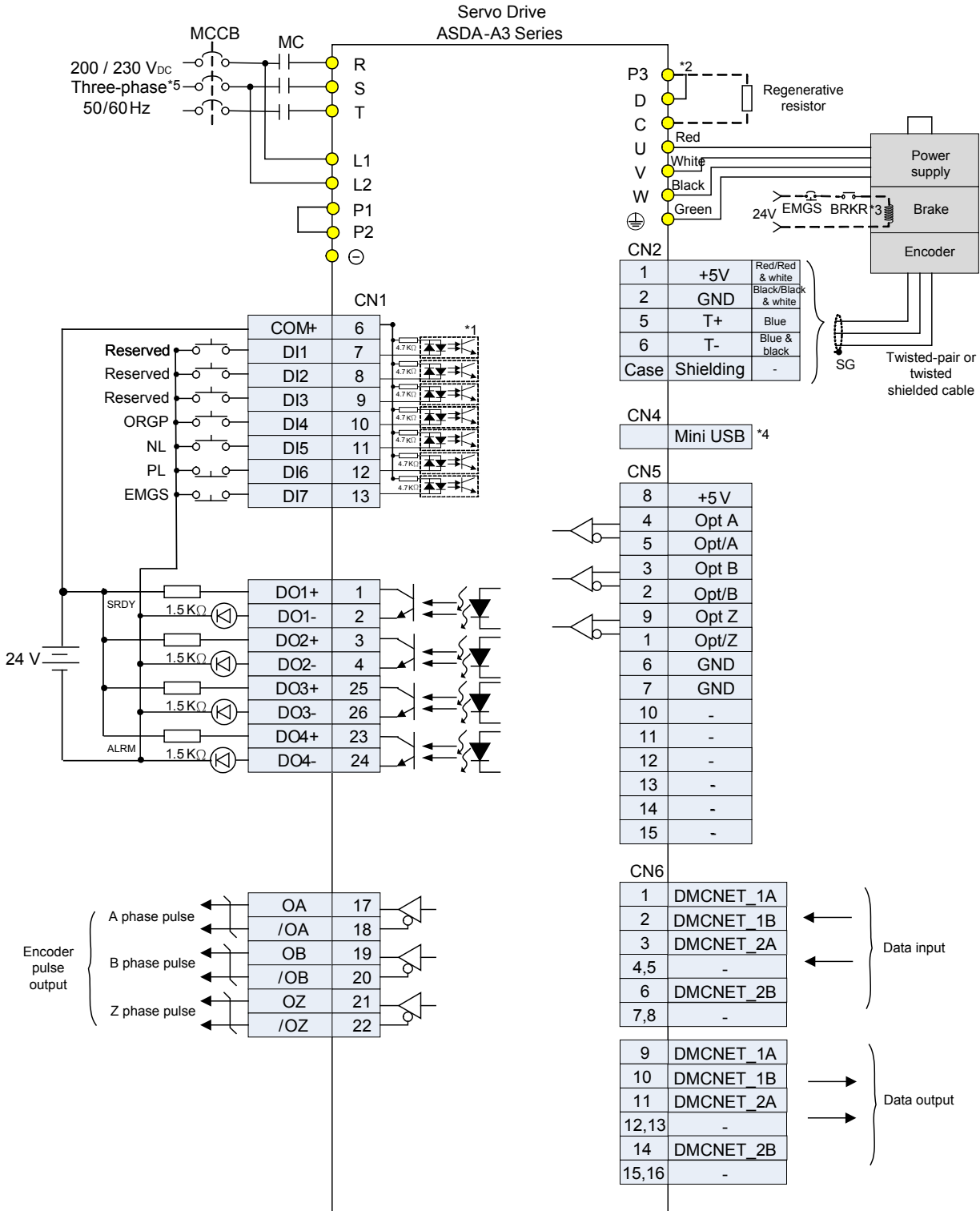

Please note:
 *1: Please refer to ASDA-A3 Series User Manual, Chapter 3.3.3 Cn1 I/O Wiring
 *2: 200 W and below do NOT provide a built-in regenerative resistor
 *3: The brake oil has no polarity
 *4: Connect to Mini-USB of PC
 *5: Single-phase connections are for servo drives 1.5kW and below only

Part Names and Functions

- **Control Circuit Input Terminal (L1, L2)**

- L1 and L2 are used to connect 200~230V_{AC}, 50/60 Hz single-phase power supply

- **DC Reactor (P1, P2)**

- Without DC reactor: Short circuit P1 and P2
- With DC reactor: connect to P1 and P2

- **Main Circuit Input Terminal (R,S,T)**

- R, S, T are used to connect to main circuit of the servo drive
- For 100 W ~ 1.5 kW servo drives: Used to connect 200 ~ 230 V_{AC}, 50/60 Hz single- phase or 3-phase power supply
- For 2 kW ~ 3 kW servo drives: Used to connect 200-230 V_{AC}, 50/60 Hz 3-phase power supply

- **STO (Safe Torque Off)**

*Note: STO function can be applied to -M servo drive models

- STO switch
- Connect to safety switch

- **PC Connection Port (CN4)**

- Used to connect PCs or notebooks for operating ASDA-SOFT software.
- A mini-USB Type B port (Note: combine Delta's USB communication modules, see p.48 for reference)

(Note: combine Delta's USB communication modules, see chapter on accessories for reference)

- **RS-485/ CANopen Communication Port Connector (CN3)**

- MODBUS communication control for RS-485
- CANopen communication control

(Note: CANopen series with two communication ports, see p.31 for reference)

- **I / O Connector (CN1)**

- Used to connect Delta's PLC products or other NC controllers

- **Encoder Connector (CN2)**

- Used to connect the encoder of the servo motor

- **Extension Module (CN9)**



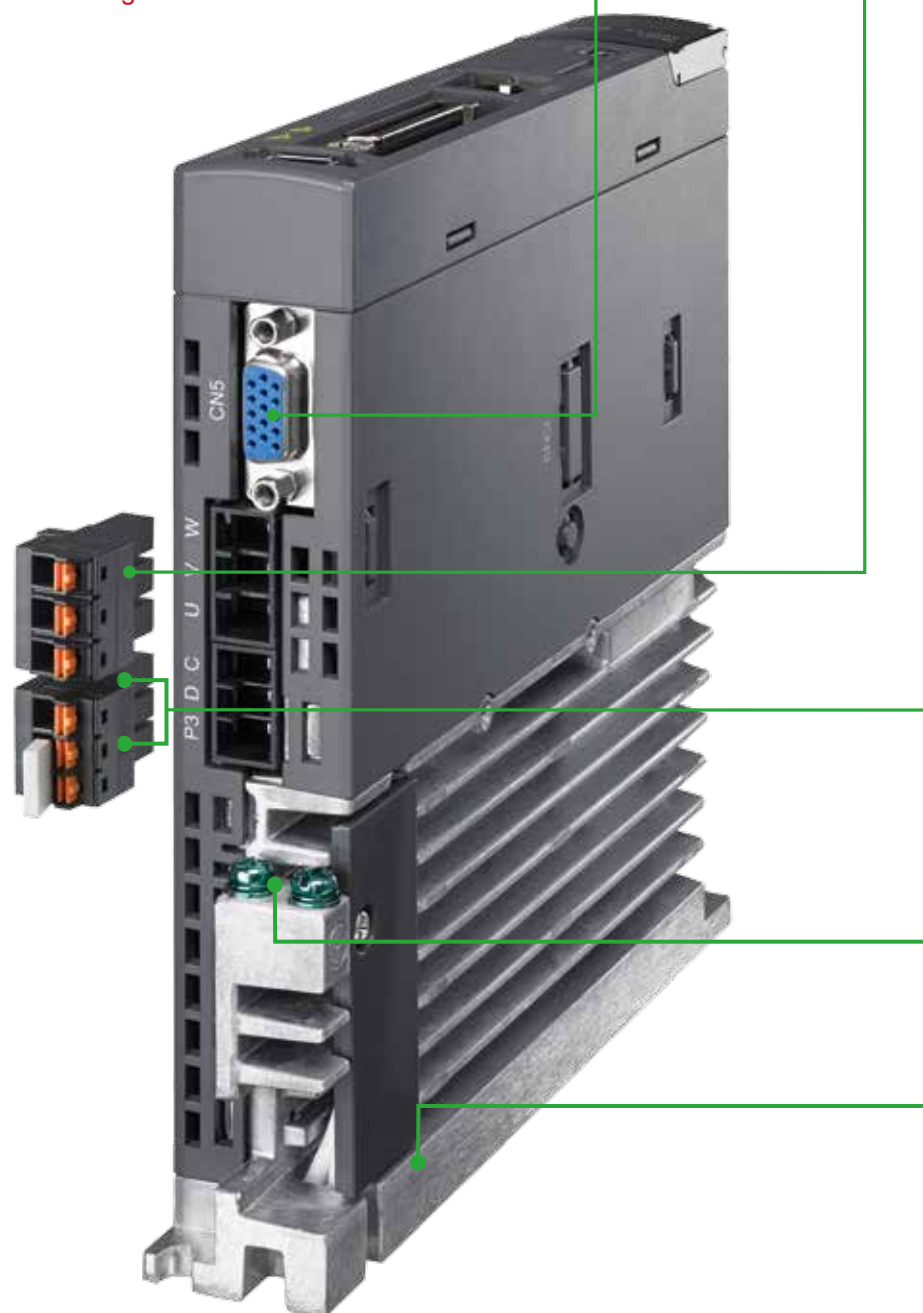

- **Full-Closed Loop Control Terminal (CN5)**
 - Used to connect external linear scale or encoder for receiving A,B,Z phase signals
- **Servo Motor Output (UVW)**
 - Used to connect servo motor terminal U, V, W. Never connect the output terminal to main circuit power as the AC drive may be damaged beyond repair if incorrect cable are connected to the output terminals
- **Braking Resistor Terminal (P3 D C)**
 - Adopt internal resistor: Ensure the circuit is closed between P3 and D, and the circuit is open between P3 and C (Note: Please refer to table of regenerative resistor specifications for the models with a built-in regenerative resistor from ASDA-A3 User Manual Chapter 2 Selecting Regenerative Resistors)
 - Adopt external resistor: Connect it to P3 and C, and ensure an open circuit between P3 and D
 - When using an external braking unit, connect it to P2 and ensure an open circuit between P3 and D ,and P3 and C
- **Ground Terminal**
 - Used to connect grounding wire of power supply and servo motor
- **Heat sink**
 - Used to secure the servo drive and for heat dissipation

ASDA-Soft Configuration Software



Auto-Tuning Function

- Step-to-step guide on using the auto tuning function
- Flow chart of the setting procedure and tuning progress
- Compare the tuning results (before & after)
- Downloadable gain parameters

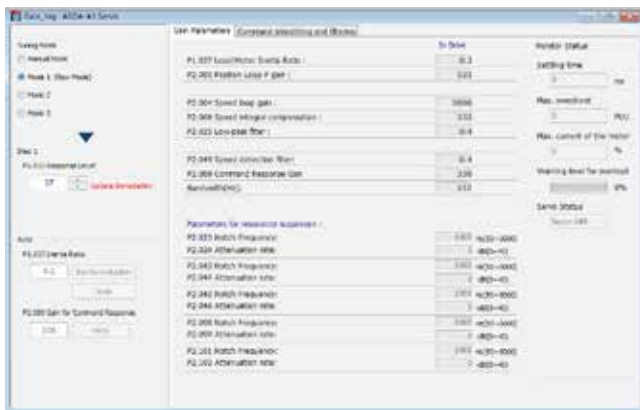

Advanced Tuning Function

- Four tuning modes available
- Manual mode: All gains tuned manually, which is for those who has profound knowledge of servo gain adjustment
- Mode 1: For fine-tuning the bandwidth
- Mode 2: For fine-tuning the inertia and bandwidth
- Mode 3: For fine-tuning the inertia, bandwidth and command responsiveness

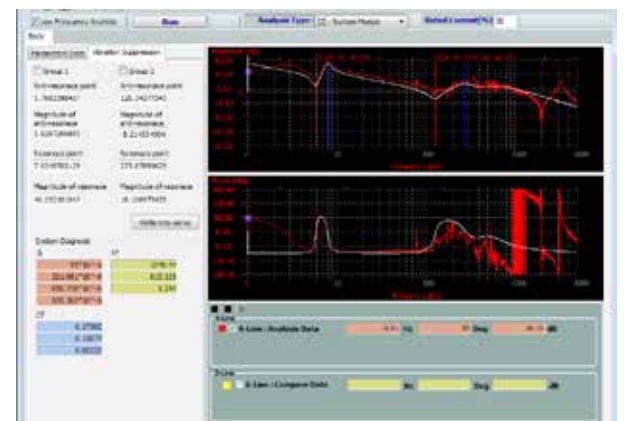

System Module and Low Frequency Analysis

- Provide analysis on rigidity of the system
- Acquire the low-frequency resonance data and automatically set the relevant parameters to eliminate the vibration with just one click
- Collect data such as inertia, elasticity and viscous friction coefficient for knowing the mechanism's features and wear condition



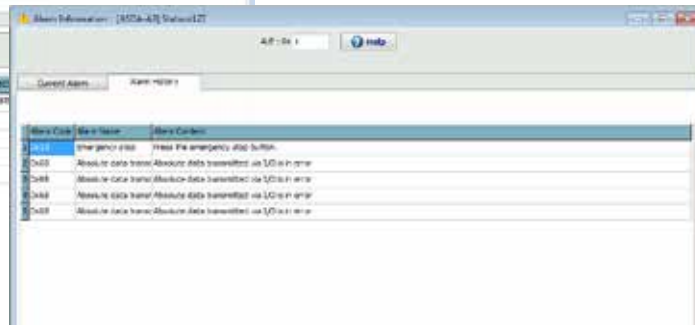
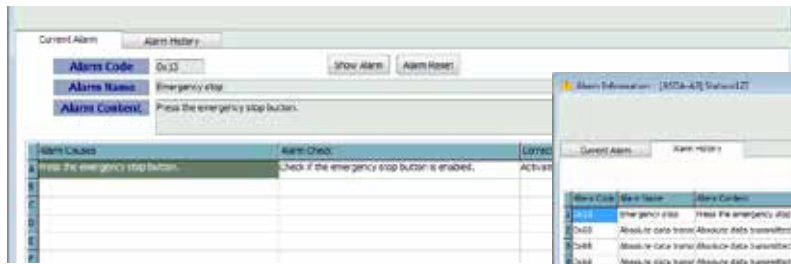

Alarm Information

- Display current alarm and alarm log
- Provide simple corrective actions for quick troubleshooting

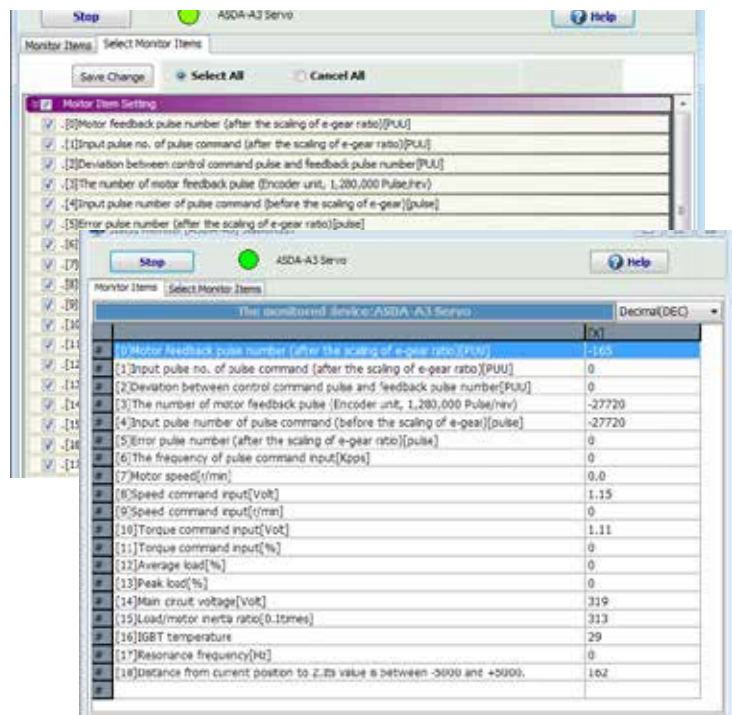

Condition Monitoring

- Real-time display of servo motor operation status via the monitoring list

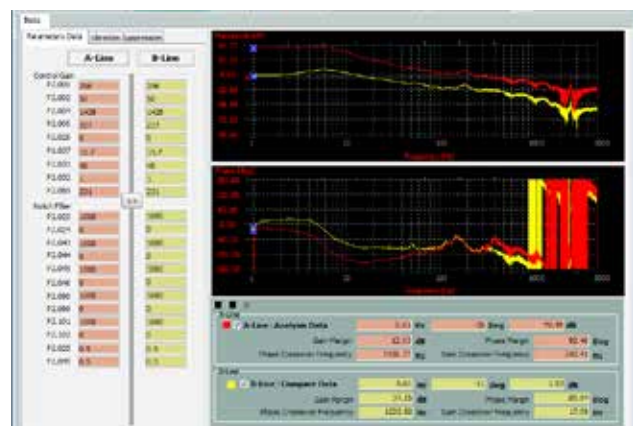

Speed Open-Loop Mode

- Acquire the gain condition for optimizing the equipment performance
- Check the system stability via monitoring the gain and phase margins

Optional Accessories

- **Quick Connectors**

- Used for 100W to 3kW servo drives.
- One operating lever is provided for wiring



- **Power Cables**

- 3 m and 5 m standard cables are available.
- Two types are selectable: with brake and without brake.



- **Encoder Cables**

- 3 m and 5 m standard cables are available.





- **Regenerative Resistor**

- For selecting a regenerative resistor, please refer to ASDA-A3 User Manual, Chapter 2.9 Selecting Regenerative Resistor



- **USB Communication Cables (for PC)**



- USB Communication Cables (for PC)
- USB1.1 is equipped as standard.



- **CANopen Accessories**

- Connect to Delta PLC CAN Master with TAP-CN03 distribution box
- CANopen communication cable is provided

Servo Drive Specifications

ASDA-A3		100 W	200 W	400 W	750 W	1 kW	1.5 kW	2 kW	3 kW	
		01	02	04	07	10	15	20	30	
Power supply	Phase / Voltage	Three-phase / Single-phase 220VAC						Single-phase 220V _{AC}		
	Permissible Voltage Range	Three-phase / Single-phase 200 ~ 230 V _{AC} · -15% ~ 10%						Single-phase 200~230VAC · -15% ~ 10%		
	Input Current(3PH) (Units: Arms)	0.67	1.34	2.67	5.01	6.68	10.02	13.36	20.05	
	Input Current(1PH) (Units: Arms)	1.16	2.31	4.63	8.68	11.57	17.36	-	-	
	Continuous Output Current (Units: Arms)	0.9	1.55	2.6	5.1	7.3	8.3	13.4	19.4	
Instantaneous Maximum Output Current (Units: Arms)		3.54	7.07	10.61	21.21	24.75	35.36	53.03	70.71	
Cooling System		Natural Air Circulation				Fan Cooling				
Servo Drive Resolution		24-bit (16777216 p/rev)								
Control of Main Circuit		SVPWM Control								
Tuning Modes		Auto / Manual								
Regenerative Resistor		None			Built-in					
Position Control Mode	Pulse Type (Only for Non-DMCNET mode)	Pulse + Direction, A phase + B + CW pulse								
	Max. Input Pulse Frequency (Only for Non-DMCNET mode)	Pulse + Direction: 4Mpps ; CCW pulse + CW pulse: 4Mpps ; A phase + B phase: Single phase 4Mpps ; Max. 200Kpps (Open collector)pps								
	Command Source	External pulse train (PT mode) (Only for Non-DMCNET mode) / Internal parameters (PR mode)								
	Smoothing Strategy	Low-pass and P-curve filter								
	Electronic Gear	Electronic gear N/M multiple N: 1~536870911, M: 1~2147483647 (1/4 < N/M < 262144)								
	Torque Limit Operation	Set by parameters								
	Feed Forward Compensation	Set by parameters								
Speed Control Mode	Analog Input Command (Only for Non-DMCNET mode)	Voltage Range	0 ~ ±10 V _{DC}							
		Resolution	15-bit							
		Input Resistance	1MΩ							
		Time Constant	25 μs							
	Speed Control Range ^{**1}	1 : 6000								
	Command Source	External analog signal (Only for Non-DMCNET mode) / Internal parameters								
	Smoothing Strategy	Low-pass and S-curve filter								
	Torque Limit Operation	Set by parameters or analog input (Only for Non-DMCNET mode)								
Frequency Response Characteristic	Maximum 3.1kHz (Closed-loop)									
	0.01% or less at 0 to 100% load fluctuation									
	0.01% or less at ±10% power fluctuation									
Speed Accuracy ^{**2}	0.01% or less at 0°C to 50°C ambient temperature fluctuation									
Torque Control Mode	Analog Input Command (Only for Non-DMCNET mode)	Voltage Range	0 ~ ±10 V _{DC}							
		Input Resistance	1MΩ							
		Time Constant	25 μs							
	Command Source	External analog signal (Only for Non-DMCNET mode) / Internal parameters								
	Smoothing Strategy	Low-pass filter								
Speed Limit	Set by parameters or analog input (Only for Non-DMCNET mode)									
Analog Monitor Output		Monitor signal can set by parameters (Output voltage range: ±8V)								
Digital Inputs / Outputs	Inputs	Servo on, Reset, Gain switching, Pulse clear, Zero speed CLAMP, Command input reverse control, Command triggered, Speed/Torque limit enabled, Position command selection, Motor stop, Speed position selection, Position / Speed mode switching, Speed / Torque mode switching, Torque / Position mode switching, PT / PR command switching, Emergency stop, Forward / Reverse inhibit limit, Reference "Home" sensor, Forward / Reverse operation torque limit, Move to "Home", Electronic Cam (E-Cam), Forward / Reverse JOG input, Event trigger PR command, Electronic gear ratio (Numerator) selection and Pulse inhibit input * Please note that the above digital signals and inputs are available only for Non-DMCNET mode. In DMCNET mode, it is recommended to write digital inputs into the servo drives through DMCNET communication, and the digital inputs should be used for Emergency Stop, Forward / Reverse Inhibit limit and Reference "Home" sensor only.								
	Outputs	Encoder signal output (A, B, Z Line Driver and Z Open Collector) Servo ready, Servo on, At Zero speed, At Speed reached, At Positioning completed, At Torques limit, Servo alarm (Servo fault) activated, Electromagnetic brake control, Homing completed, Output overload warning, Servo warning activated, Position command overflow, Forward / Reverse software limit, Internal position command completed, Capture operation completed output., Motion control completed output., Master position of E-Cam (Electronic Cam)								
Protective Functions		Overcurrent, Overvoltage, Undervoltage, Motor overheated, Regeneration error, Overload, Overspeed, Abnormal pulse control command, Excessive deviation, Encoder error, Adjustment error, Emergency stop activated, Reverse/ Forward limit switch error, Position excessive deviation of full-close control loop, Serial communication error, Input power phase loss, Serial communication time out, short circuit protection of U, V, W, and CN1, CN2, CN3 terminals								
Communication Interface		RS-485 / CANopen / USB								
Environment	Installation Site		Indoor environment (free of direct sunlight), no corrosive liquid and gas (free of oil mist, flammable gas, or dust)							
	Altitude		Altitude 1000m or lower above sea level							
	Atmospheric Pressure		86kPa ~ 106kPa							
	Operating Temperature		0°C ~ 55°C (If operating temperature is above 45°C, forced cooling will be required)							
	Storage Temperature		-20 °C ~ 65 °C							
	Humidity		0 ~ 90% RH (non-condensing)							
	Vibration		9.80665 m/s ² (1G) less than 20Hz, 5.88 m/s ² (0.6G) 20 to 50Hz							
	IP Rating		IP20							
Power System		TN System ^{**3,4}								
Approvals		IEC/EN 61800-5-1 · UL 508C  								

Note: *1. When it is with the rated load, the speed ratio is: the minimum speed (smooth operation) / rated speed.

*2. When the command is the rated speed, the velocity correction ratio is: (free run speed - full load speed) / rated speed

*3. TN system: The neutral point of the power system connects to the ground directly. The exposed metal components connect to the ground via the protective earth conductor.

*4. Use a single-phase three-wire power systems for models of single-phase power

Servo Drive Dimensions

100W / 200W

Weight
0.84 kg

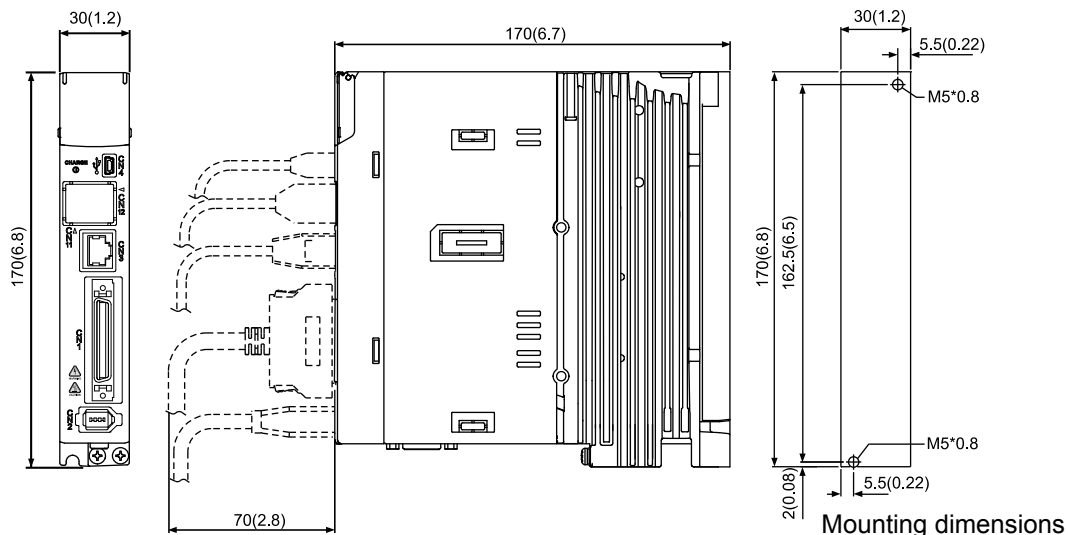

- ⊕ ⊖ SCREW: M4x0.7
- ⊗ ⊗ Mounting screw torque: 14 (kgf-cm)

Unit: mm (inch)

400W

Weight
0.92kg

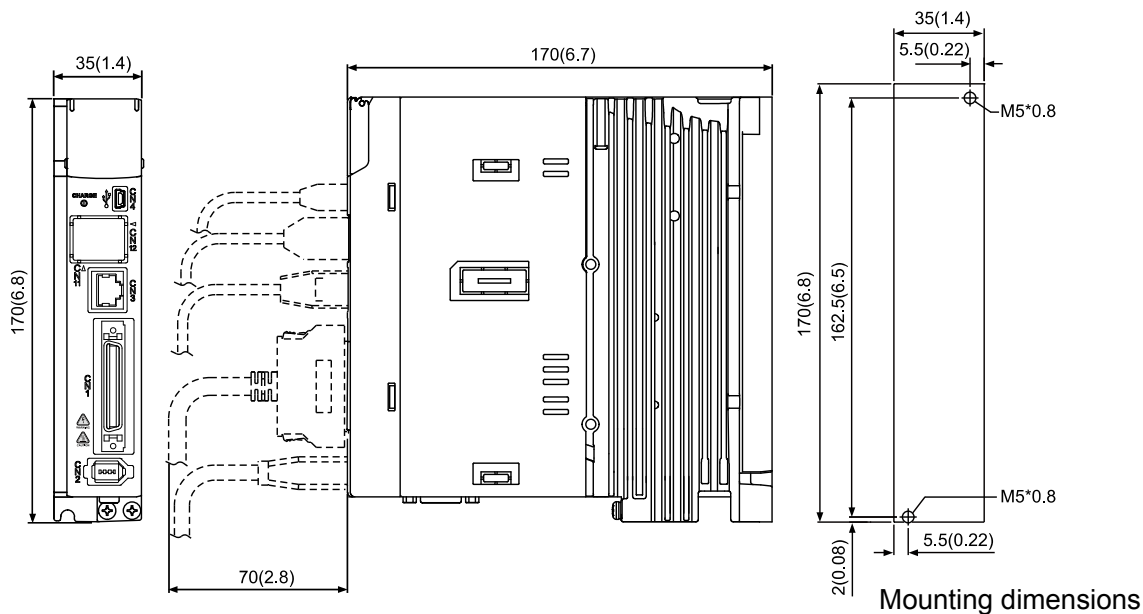

- ⊕ ⊖ SCREW: M4x0.7
- ⊗ ⊗ Mounting screw torque: 14 (kgf-cm)

Unit: mm (inch)

Note:
1. Dimensions are in millimeters (inches); Weights are in kilograms (kg) and pounds (lbs).
2. Dimensions and weights of the servo drive may be revised without prior notice.

Servo Drive Dimensions

Unit: mm [inch]

750W / 1kW / 1.5kW

Weight
1.3kg

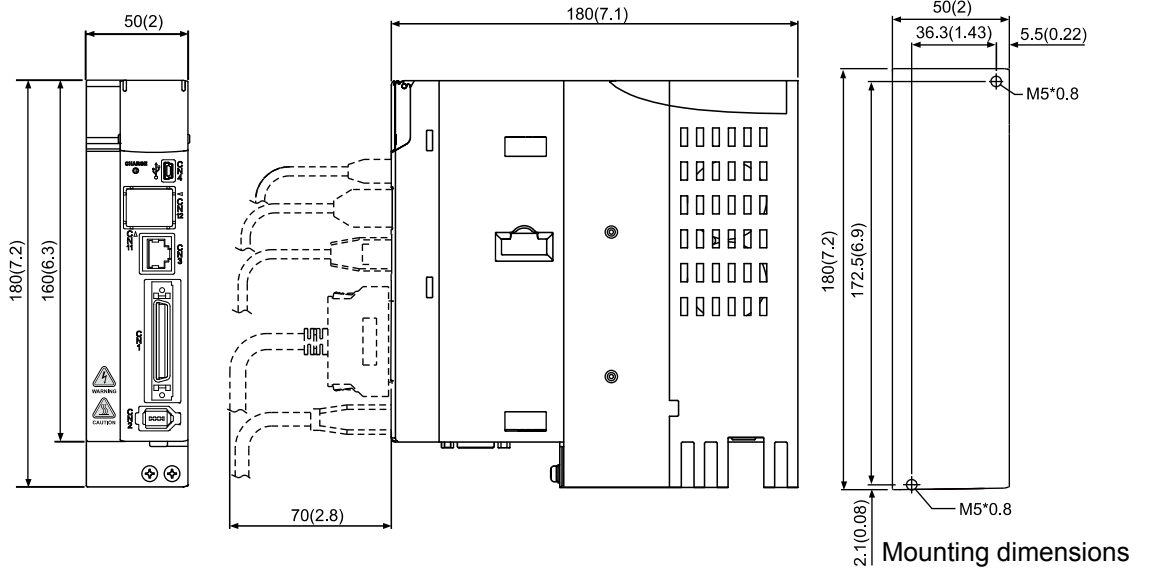

- ⊕ ⊖ SCREW: M4x0.7
- ⊗ ⊙ Mounting screw torque: 14 (kgf-cm)

Unit: mm (inch)

2kW / 3kW

Weight
2.7kg

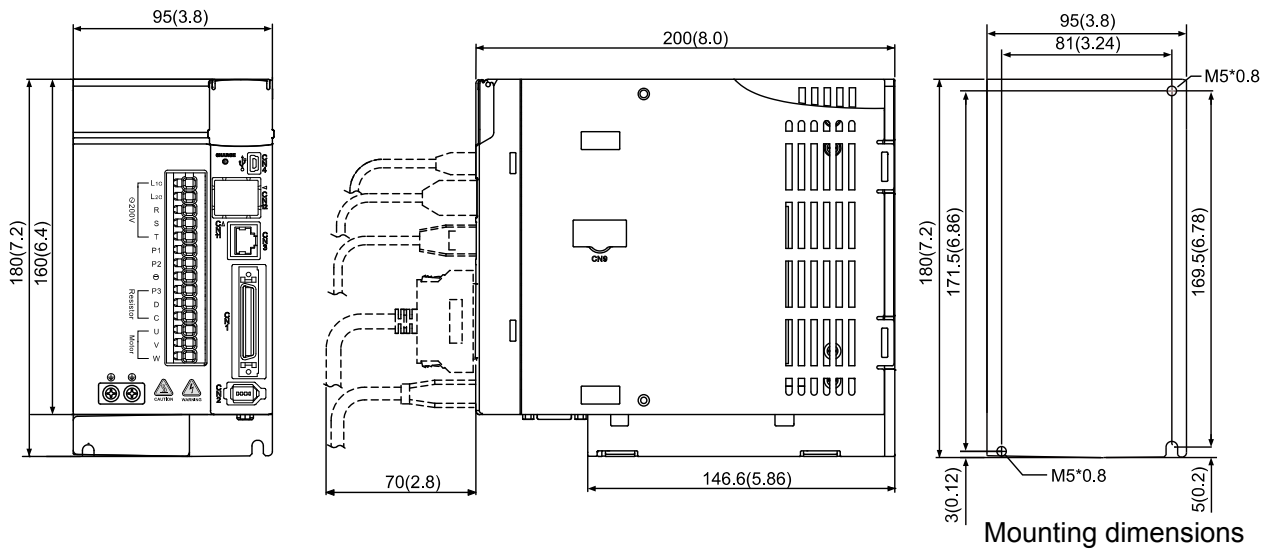

- ⊕ ⊖ SCREW: M4x0.7
- ⊗ ⊙ Mounting screw torque: 14 (kgf-cm)

Unit: mm (inch)

Note:
 1. Dimensions are in millimeters (inches); Weights are in kilograms (kg) and pounds (lbs).
 2. Dimensions and weights of the servo drive may be revised without prior notice.

Optional Cables and Connectors

• Power Connectors

ASDBCAPW0000 (for 200V drives)

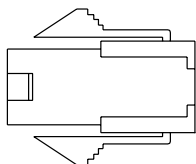

ASD-CAPW1000

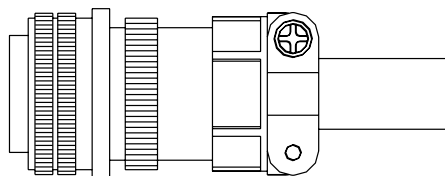

ASDBCAPW0100 (for 200V drives, with brake cable)

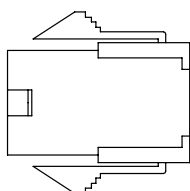

ASD-CAPW2000

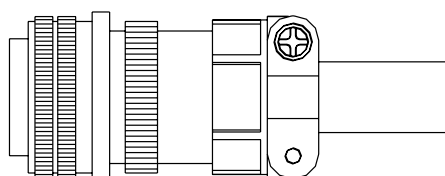

• Power Cables

ACS3-CAPW1103, ACS3-CAPW1105 (for 200V drives)

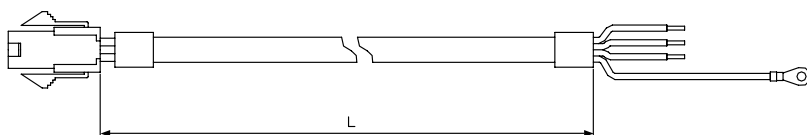

Item	Part No.	L	
		mm	inch
1	ACS3-CAPW1103	3000 ± 100	118 ± 4
2	ACS3-CAPW1105	5000 ± 100	197 ± 4

ACS3-CAPW2103, ACS3-CAPW2105 (for 200V drives, with brake cable)

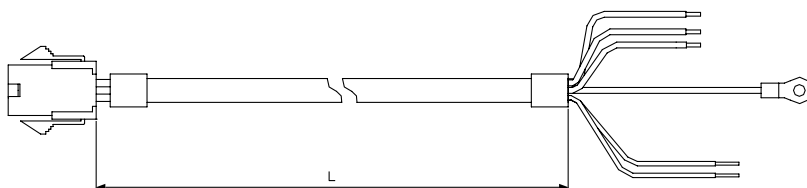

Item	Part No.	L	
		mm	inch
1	ACS3-CAPW2103	3000 ± 100	118 ± 4
2	ACS3-CAPW2105	5000 ± 100	197 ± 4

Optional Cables and Connectors

• Power Cables

ACS3-CAPW1203, ACS3-CAPW1205

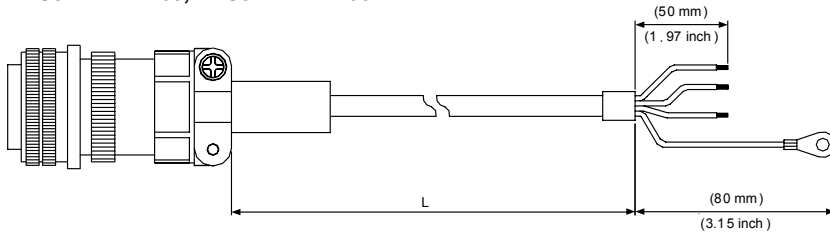

Item	Part No.	Straight	L	
			mm	inch
1	ACS3-CAPW1203	3106A-20-18S	3000 ± 100	118 ± 4
2	ACS3-CAPW1205	3106A-20-18S	5000 ± 100	197 ± 4

ACS3-CAPW2203, ACS3-CAPW2205 (with brake cable)

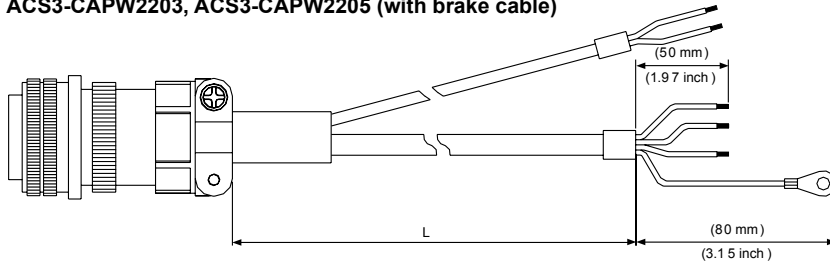

Item	Part No.	Straight	L	
			mm	inch
1	ACS3-CAPW2203	3106A-20-18S	3000 ± 100	118 ± 4
2	ACS3-CAPW2205	3106A-20-18S	5000 ± 100	197 ± 4

ACS3-CAPW1303, ACS3-CAPW1305

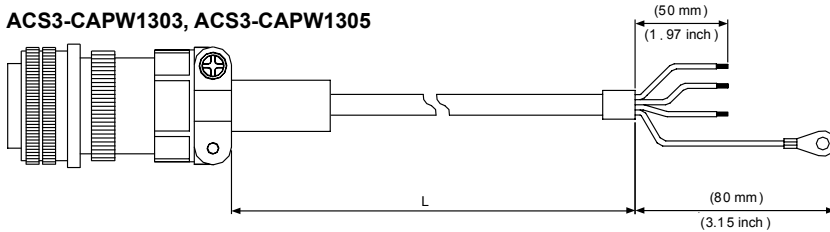

Item	Part No.	Straight	L	
			mm	inch
1	ACS3-CAPW1303	3106A-20-18S	3000 ± 100	118 ± 4
2	ACS3-CAPW1305	3106A-20-18S	5000 ± 100	197 ± 4

ACS3-CAPW2303, ACS3-CAPW2305 (with brake cable)

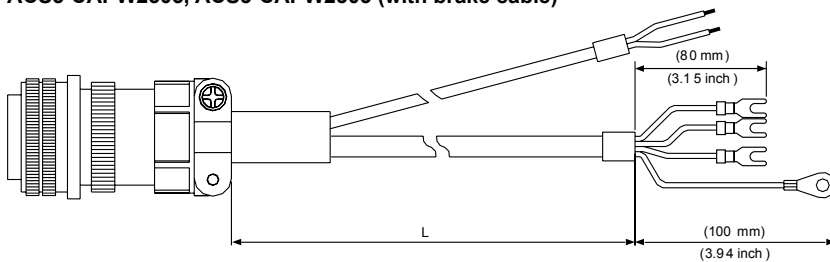

Item	Part No.	Straight	L	
			mm	inch
1	ACS3-CAPW2303	3106A-20-18S	3000 ± 100	118 ± 4
2	ACS3-CAPW2305	3106A-20-18S	5000 ± 100	197 ± 4

• Power Cables

ACS3-CAPW1403, ACS3-CAPW1405

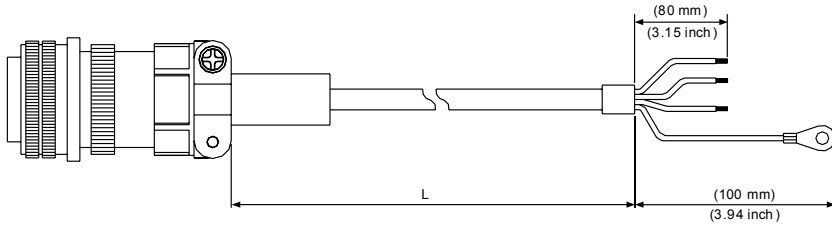

Item	Part No.	Straight	L	
			mm	inch
1	ACS3-CAPW1403	3106A-24-11S	3000 ± 100	118 ± 4
2	ACS3-CAPW1405	3106A-24-11S	5000 ± 100	197 ± 4

ACS3-CAPW2403, ACS3-CAPW2405 (with brake cable)

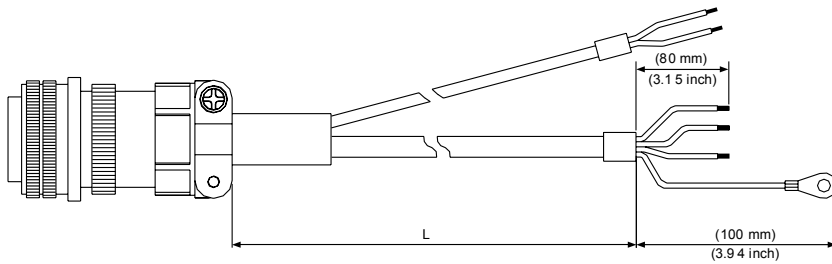

Item	Part No.	Straight	L	
			mm	inch
1	ACS3-CAPW2403	3106A-24-11S	3000 ± 100	118 ± 4
2	ACS3-CAPW2405	3106A-24-11S	5000 ± 100	197 ± 4

• Incremental Encoder Cables

ACS3-CAEN1003, ACS3-CAEN1005

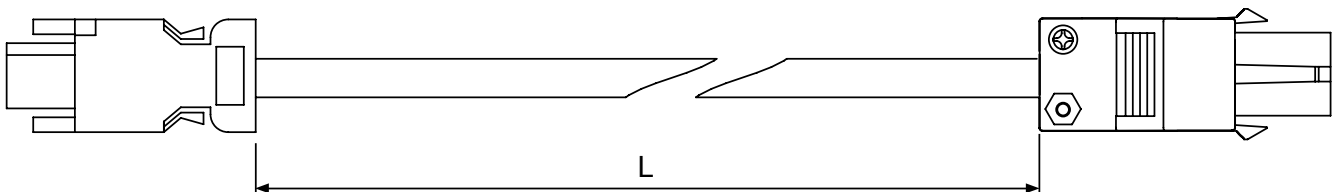

Item	Part No.	L	
		mm	inch
1	ACS3-CAEN1003	3000 ± 100	118 ± 4
2	ACS3-CAEN1005	5000 ± 100	197 ± 4

Optional Cables and Connectors

• Incremental Encoder Cables

ACS3-CAEN3003, ACS3-CAEN3005

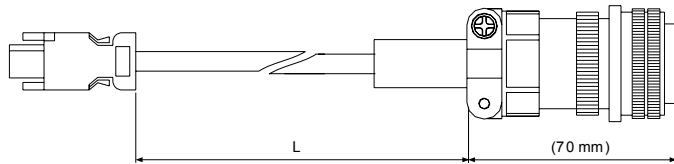

Item	Part No.	Straight	L	
			mm	inch
1	ACS3-CAEN3003	3106A-20-29S	3000 ± 100	118 ± 4
2	ACS3-CAEN3005	3106A-20-29S	5000 ± 100	197 ± 4

• Absolute Encoder Cables

ACS3-CAEA1003, ACS3-CAEA1005

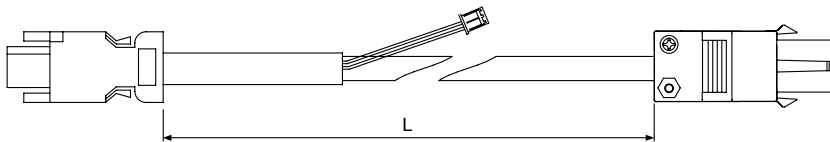

Item	Part No.	L	
		mm	inch
1	ACS3-CAEA1003	3000 ± 100	118 ± 4
2	ACS3-CAEA1005	5000 ± 100	197 ± 4

ACS3-CAEA3003, ACS3-CAEA3005

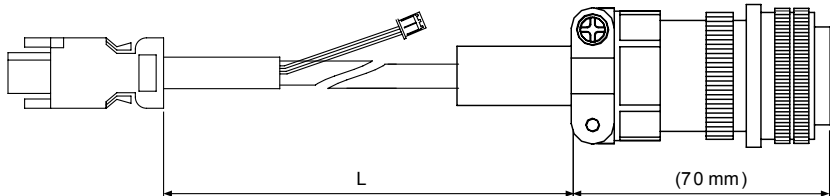

Item	Part No.	L	
		mm	inch
1	ACS3-CAEA3003	3000 ± 100	118 ± 4
2	ACS3-CAEA3005	5000 ± 100	197 ± 4

• Battery Box Cord AW (Connects to the battery side of the encoder cable) Units: mm

3864573700

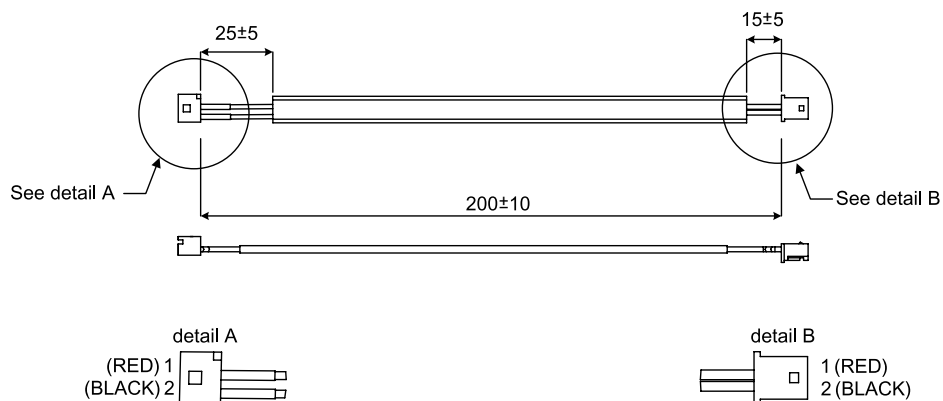

Unit:mm

• **Battery Boxes with batteries** Units: mm

Single Battery Box
ASD-MDBT0100

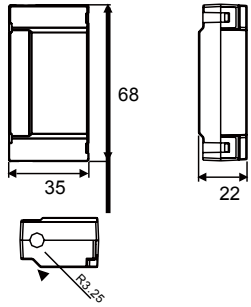

Dual Battery Box
ASD-MDBT0200

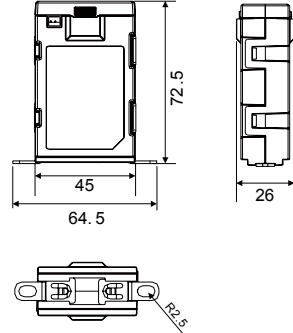

• **I/O Signal Connector (CN1)**

ACS3-CNADC150

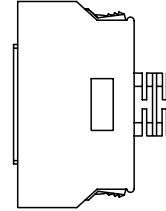

• **Terminal Block Module**

ACS3-MDTB5000

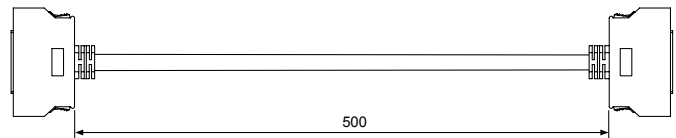
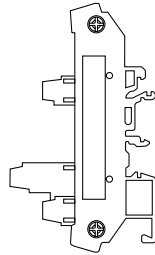
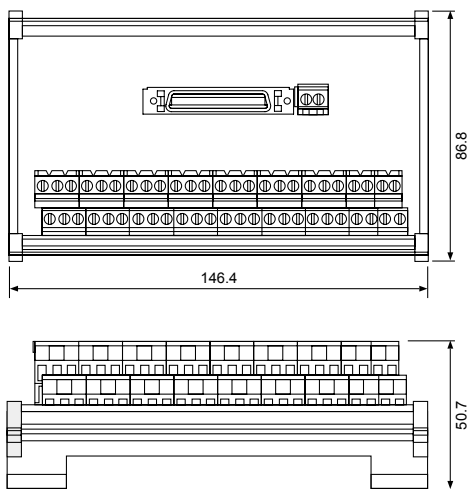

Unit: mm

• **CANopen Communication Cable**

UC-CMC030-01A, UC-CMC050-01A

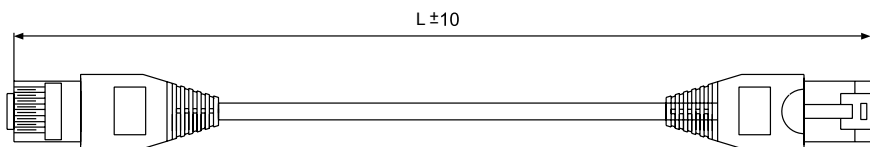

Item	Part No.	L	
		mm	inch
1	UC-CMC030-01A	300 ± 10	11 ± 0.4
2	UC-CMC050-01A	500 ± 10	19 ± 0.4

Optional Cables and Connectors

• CANopen Distribution Box Units: mm [inch]

TAP-CN03

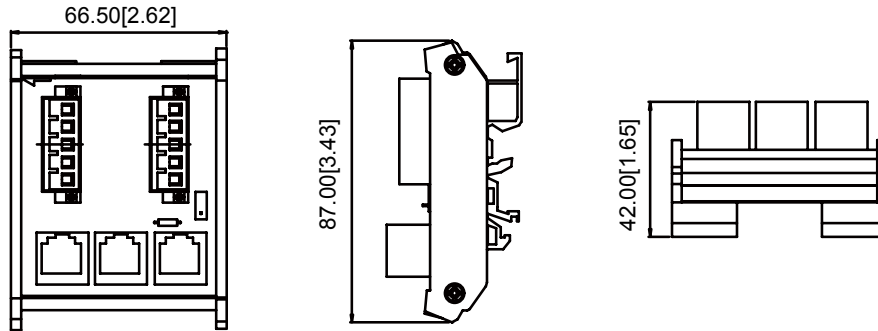

NOTE 1) More accessories for ASDA-A3 coming soon.
2) Accessories images shown here may differ from actual product appearance.

• Ferrite Rings

ASD-ACFC7K00

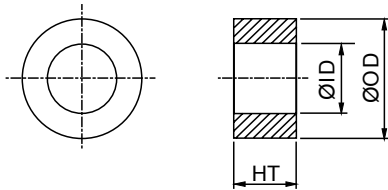

Part No.	Outer Diameter	Inner Diameter	height
ASD-ACFC7K00	68.0 ± 0.6	44.0 ± 0.6	13.5 ± 0.5

• A3 / A2 Adapter Cable

A3/A2 CN1 Adapter Cable

3081709800

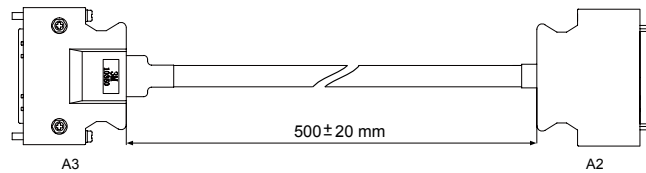

A3/A2 CN2 Adapter Cable

3081709600

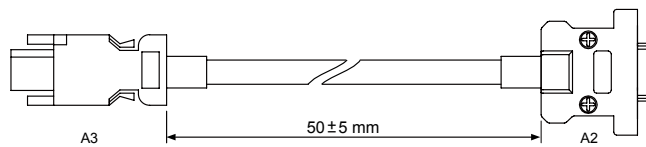

A3/A2 CN5 Adapter Cable

3081709700

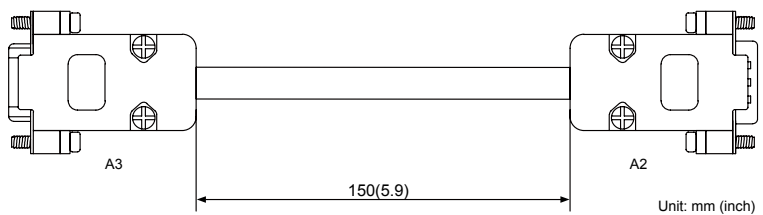

Unit: mm (inch)

• **A3 CN3 RS-485 / CANOpen Tap**

ACS3-CNADC3RC

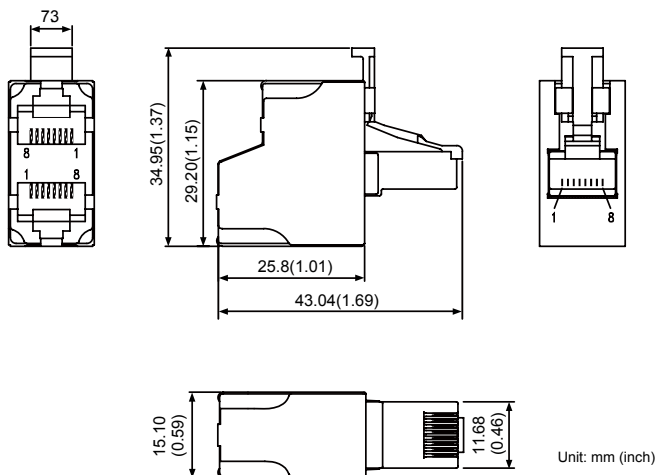

• **A3 CN3 RS-485 / CANOpen Termination Resistor**

ACS3-CNADC3TR

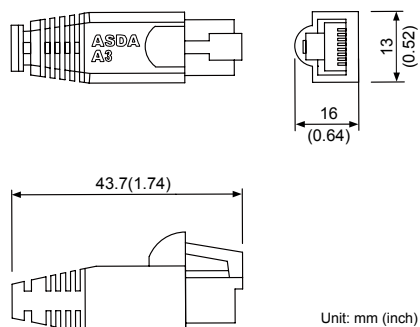

• **CN4 Mini USB module**

UC-PRG015-01B, UC-PRG030-01B

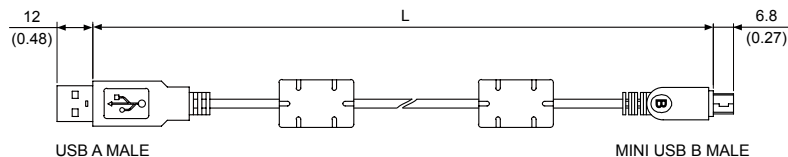
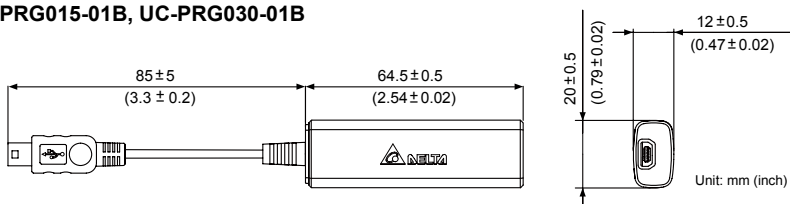

Item	Part No.	L	
		mm	inch
1	UC-PRG015-01B	1500 ± 100	59 ± 4
2	UC-PRG030-01B	3000 ± 100	118 ± 4

UC-ADP01-A

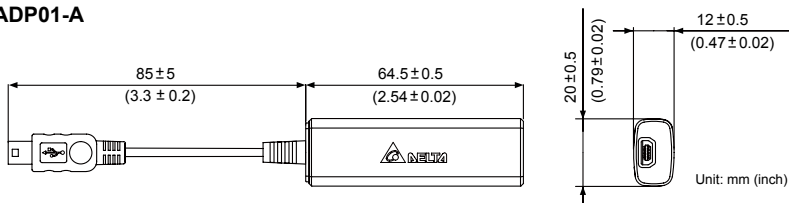

UC-PRG015-01A, UC-PRG030-01A

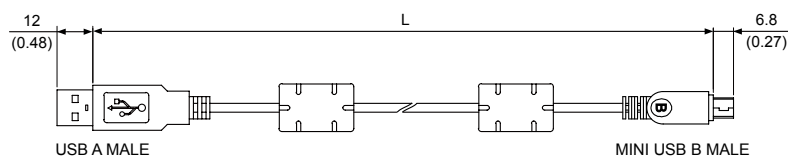

Item	Part No.	L	
		mm	inch
1	UC-PRG015-01A	1500 ± 100	59 ± 4
2	UC-PRG030-01A	3000 ± 100	118 ± 4

Servo Drive Accessories Combinations

100W Servo Drive and 50W Low / High Inertia Servo Motor

Servo Ddrive	ASD-A3-0121-□
Servo Motor Model Name	ECM-A3L-C△040F□S1 ECM-A3L-C△040I□S1 ECM-A3H-C△040F□S1 ECM-A3H-C△040I□S1
Power Cable (Without Brake)	ACS3-CAPW110X
Power Connector (Without Brake)	ASDBCAPW0000
Power Cable (With Brake)	ACS3-CAPW210X
Power Connector (With Brake)	ASDBCAPW0100
Incremental Encoder Cable	ACS3-CAEN100X
Absolute Encoder Cable	ACS3-CAEA100X

(X=3 indicates that the cable length is 3m; X=5 indicates that the cable length is 5m)

750W Servo Drive and 750W Low / High Inertia Servo Motor

Servo Ddrive	ASD-A3-0721-□
Low Inertia Servo Motor	ECM-A3L-C△0807□S1 ECM-A3H-C△0807□S1
Power Cable (Without Brake)	ACS3-CAPW110X
Power Connector (Without Brake)	ASDBCAPW0000
Power Cable (With Brake)	ACS3-CAPW210X
Power Connector (With Brake)	ASDBCAPW0100
Incremental Encoder Cable	ACS3-CAEN100X
Absolute Encoder Cable	ACS3-CAEA100X

(X=3 indicates that the cable length is 3m; X=5 indicates that the cable length is 5m)

200W Servo Drive and 200W Low / High Inertia Servo Motor

Servo Ddrive	ASD-A3-0221-□
Servo Motor Model Name	ECM-A3L-C△0602□S1 ECM-A3H-C△0602□S1
Power Cable (Without Brake)	ACS3-CAPW110X
Power Connector (Without Brake)	ASDBCAPW0000
Power Cable (With Brake)	ACS3-CAPW210X
Power Connector (With Brake)	ASDBCAPW0100
Incremental Encoder Cable	ACS3-CAEN100X
Absolute Encoder Cable	ACS3-CAEA100X

(X=3 indicates that the cable length is 3m; X=5 indicates that the cable length is 5m)

1 kW/1kW Servo Drive and 1kW Medium Inertia Servo Motor and 850W High Inertia Servo Motor

Servo Ddrive	ASD-A3-1021-□
Medium Inertia Servo Motor	ECMC-CW1010□S ECMC-EW1310□S ECMC-FW1308□S
Power Cable (Without Brake)	ACS3-CAPW120X
Power Cable (With Brake)	ACS3-CAPW220X
Power Connector	ASD-CAPW1000
Incremental Encoder Cable	ACS3-CAEN300X
Absolute Encoder Cable	ACS3-CAEA300X

(X=3 indicates that the cable length is 3m; X=5 indicates that the cable length is 5m)

400W Servo Drive and 400W Low / High Inertia Servo Motor

Servo Ddrive	ASD-A3-0421-□
Servo Motor Model Name	ECM-A3L-C△0604□S1 ECM-A3L-C△0804□S1 ECM-A3H-C△0604□S1 ECM-A3H-C△0804□S1
Power Cable (Without Brake)	ACS3-CAPW110X
Power Connector (Without Brake)	ASDBCAPW0000
Power Cable (With Brake)	ACS3-CAPW210X
Power Connector (With Brake)	ASDBCAPW0100
Incremental Encoder Cable	ACS3-CAEN100X
Absolute Encoder Cable	ACS3-CAEA100X

(X=3 indicates that the cable length is 3m; X=5 indicates that the cable length is 5m)

1.5kW Servo Drive and 1.5kW Medium Inertia Servo Motor

Servo Ddrive	ASD-A3-1521-□
High Inertia Servo Motor	ECMC-CW1315□S
Power Cable (Without Brake)	ACS3-CAPW120X
Power Cable (With Brake)	ACS3-CAPW220X
Power Connector	ASD-CAPW1000
Incremental Encoder Cable	ACS3-CAEN300X
Absolute Encoder Cable	ACS3-CAEA300X

(X=3 indicates that the cable length is 3m; X=5 indicates that the cable length is 5m)

2kW Servo Drive and 2kW Medium Inertia Servo Motor and 1.3kW, 1.8kW High Inertia Servo Motor

Servo Drive	ASD-A3-2023□
Low Inertia Servo Motor	ECMC-EW1320□S ECMC-FW1313□S ECMC-FW1318□S
Power Cable (Without Brake)	ACS3-CAPW130X
Power Cable (With Brake)	ACS3-CAPW230X
Power Connector	ASD-CAPW1000
Incremental Encoder Cable	ACS3-CAEN300X
Absolute Encoder Cable	ACS3-CAEA300X

(X=3 indicates that the cable length is 3m; X=5 indicates that the cable length is 5m)

2kW Servo Drive and 2kW Medium Inertia Servo Motor

Servo Drive	ASD-A3-2023-□
High Inertia Servo Motor	ECMC-EW1820□S
Power Cable (Without Brake)	ACS3-CAPW140X
Power Cable (With Brake)	ACS3-CAPW240X
Power Connector	ASD-CAPW2000
Incremental Encoder Cable	ACS3-CAEN300X
Absolute Encoder Cable	ACS3-CAEA300X

(X=3 indicates that the cable length is 3m; X=5 indicates that the cable length is 5m)

3kW Servo Drive and 3kW Medium Inertia Servo Motor

Servo Drive	ASD-A3-3023-□
High Inertia Servo Motor	ECMC-EW1830□S ECMC-FW1830□S
Power Cable (Without Brake)	ACS3-CAPW140X
Power Cable (With Brake)	ACS3-CAPW240X
Power Connector	ASD-CAPW2000
Incremental Encoder Cable	ACS3-CAEN300X
Absolute Encoder Cable	ACS3-CAEA300X

(X=3 indicates that the cable length is 3m; X=5 indicates that the cable length is 5m)





Smarter. Greener. Together.

Industrial Automation Headquarters

Delta Electronics, Inc.

Taoyuan Technology Center
18 Xinglong Road, Taoyuan District,
Taoyuan City 33068, Taiwan (R.O.C.)
TEL: 886-3-362-6301 / FAX: 886-3-371-6301

Asia

Delta Electronics (Jiangsu) Ltd.

Wujiang Plant 3
1688 Jiangxing East Road,
Wujiang Economic Development Zone
Wujiang City, Jiang Su Province, P.R.C. 215200
TEL: 86-512-6340-3008 / FAX: 86-769-6340-7290

Delta Greentech (China) Co., Ltd.

238 Min-Xia Road, Pudong District,
ShangHai, P.R.C. 201209
TEL: 86-21-58635678 / FAX: 86-21-58630003

Delta Electronics (Japan), Inc.

Tokyo Office
2-1-14 Minato-ku Shibadaimon,
Tokyo 105-0012, Japan
TEL: 81-3-5733-1111 / FAX: 81-3-5733-1211

Delta Electronics (Korea), Inc.

1511, Byucksan Digital Valley 6-cha, Gasan-dong,
Geumcheon-gu, Seoul, Korea, 153-704
TEL: 82-2-515-5303 / FAX: 82-2-515-5302

Delta Electronics Int'l (S) Pte Ltd.

4 Kaki Bukit Ave 1, #05-05, Singapore 417939
TEL: 65-6747-5155 / FAX: 65-6744-9228

Delta Electronics (India) Pvt. Ltd.

Plot No 43 Sector 35, HSIIDC
Gurgaon, PIN 122001, Haryana, India
TEL : 91-124-4874900 / FAX : 91-124-4874945

Americas

Delta Products Corporation (USA)

Raleigh Office
P.O. Box 12173, 5101 Davis Drive,
Research Triangle Park, NC 27709, U.S.A.
TEL: 1-919-767-3800 / FAX: 1-919-767-8080

Delta Greentech (Brasil) S.A.

Sao Paulo Office
Rua Itapeva, 26 - 3° andar Edificio Itapeva One-Bela Vista
01332-000-São Paulo-SP-Brazil
TEL: 55 11 3568-3855 / FAX: 55 11 3568-3865

Europe

Delta Electronics (Netherlands) B.V.

Eindhoven Office
De Witbogt 20, 5652 AG Eindhoven, The Netherlands
TEL: +31 (0)40-8003800 / FAX: +31 (0)40-8003898

*We reserve the right to change the information in this catalogue without prior notice.